

RAD TORQUE SYSTEMS - THERE IS A BETTER WAY

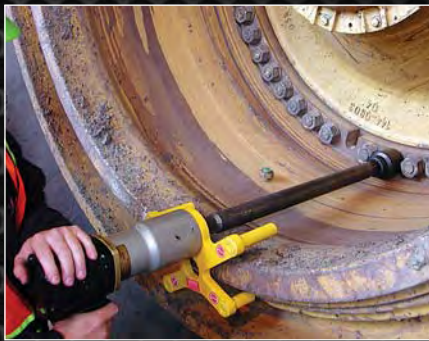

LEADING MANUFACTURER OF ADVANCED TORQUE SYSTEMS



PNEUMATIC



BATTERY



ELECTRONIC



ELECTRIC



PNEUMATIC SERIES

Classic	2
High Speed	3
Gen-X	4
Wheel Nut Bolting	5



BATTERY SERIES

B Series	6
----------------	---



ELECTRONIC SERIES

E Series	7-8
Controllers	9



ELECTRIC SERIES

V Series	10
----------------	----



ACCESSORIES

Reaction Arms	11
Nose Extensions	12
Torque Analyzers	13

COMPANY PROFILE	14
-----------------------	----



RAD[®] CLASSIC SERIES

RAD[®] CLASSIC SERIES torque wrenches offer a reliable and dependable solution for the installation and removal of heavy-duty fasteners in a variety of industries that require accuracy, power, and safety.

- ✓ *PATENTED planetary gear reduction drive system delivering one of the highest power-to-weight ratios of any pneumatic controlled bolting system*
- ✓ *Smooth continuous flow of controlled torque eliminating destructive hammering*
- ✓ *Lightweight ergonomic pistol grip design reducing operator strain and injury; resulting in increased productivity*
- ✓ *Controlled torque – accuracy of +/-5%, and repeatability of +/-2%*



Unmatched accuracy through precision engineering and design



RAD[®] 475SL



RAD[®] 2400NG

CLASSIC SERIES DIMENSIONS

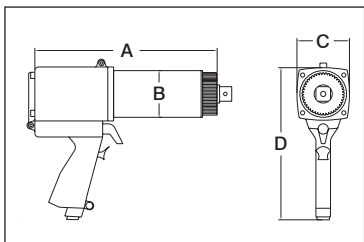

All RAD[®] Pneumatic Series tools include reaction arm, 12' hose & fittings and all new ergonomic regulator cage



RAD[®] 6800

PART NUMBER	TOOL MODEL	DRIVE SIZE	TORQUE (Nm)		RPM	WEIGHT (Kg)	NOISE LEVEL	DIMENSION A	DIMENSION B	DIMENSION C	DIMENSION D
			LOW	HIGH							
13573	475SL	0.75"	70	475	65	2.7	80 db	167mm	60mm	69mm	222mm
13579	750SL	0.75"	150	750	35	2.9	80 db	185mm	60mm	69mm	222mm
13543	1100NG	0.75"	200	1100	30	4.3	85 db	196mm	72mm	83mm	241mm
13553	1900NG	1.0"	400	1900	15	5.6	85 db	228mm	76mm	83mm	241mm
13559	2400NG	1.0"	700	2450	13	5.6	85 db	228mm	76mm	83mm	241mm
13567	4000	1.0"	1400	4050	14	9.2	85 db	335mm	78mm	93mm	264mm
13577	6800	1.5"	2000	6800	8	12.7	85 db	353mm	101mm	93mm	264mm

Visit our website for a complete up-to-date list of products.

PNEUMATIC SERIES

RAD® HIGH SPEED SERIES

Introduced to compliment the RAD® classic series torque wrenches, **RAD® HIGH SPEED SERIES** torque wrenches offer the same reliable and dependable solution for the installation and removal of heavy-duty fasteners where accuracy, power, and safety are required. **RAD® HIGH SPEED SERIES** torque wrenches incorporate a precision engineered *high speed* gear box designed for faster run down on time sensitive bolting applications reaching speeds as high as 300 rpm.



Extreme torque with high RPM productivity



RAD® 475SL-2



RAD® 1100NG-2



RAD® 1900NG-2

HIGH SPEED SERIES DIMENSIONS

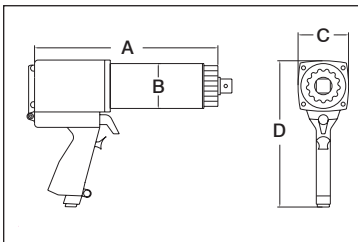

Torque (Ft. Lb.)	Pressure (PSI)
200	30
250	37
300	45
350	52
400	60
450	68
500	76
550	85

All RAD® Pneumatic Series tools include a laminated torque/PSI chart, assuring maximum accuracy and performance

PART NUMBER	TOOL MODEL	DRIVE SIZE	TORQUE (Nm) LOW	TORQUE (Nm) HIGH	RPM	WEIGHT (Kg)	NOISE LEVEL	DIMENSION A	DIMENSION B	DIMENSION C	DIMENSION D
13575	475SL-2	0.75"	150	475	300	3.7	80 db	228mm	60mm	69mm	222mm
13581	750SL-2	0.75"	275	750	170	4.0	80 db	241mm	60mm	69mm	222mm
13545	1100NG-2	0.75"	400	1100	170	5.2	85 db	247mm	72mm	83mm	241mm
13555	1900NG-2	1.0"	700	1900	69	7.2	85 db	292mm	76mm	83mm	241mm
13561	2400NG-2	1.0"	950	2450	53	7.2	85 db	292mm	76mm	83mm	241mm
13569	4000-2	1.0"	1900	4050	55	11.3	85 db	398mm	78mm	86mm	264mm

Visit our website for a complete up-to-date list of products.

Accuracy of +/-5%, Repeatability of +/-2%

RAD[®] GEN-X SERIES

Precision design and engineering has brought about the next generation in torque wrenches – the **RAD[®] GEN-X SERIES**.

Designed for extreme duty use in a variety of industries worldwide, **RAD[®] GEN-X SERIES** torque wrenches offer:

- ✓ The ultimate in power-to-weight ratio
- ✓ Wide torque range to suit multiple applications
- ✓ Unmatched reliability delivered by one of the most advanced engineered gear boxes on the market



Extreme Duty Torque Wrenches for Heavy Duty Applications



RAD[®] 14GX



RAD[®] 34GX



CE RAD[®] 46GX

GEN-X SERIES DIMENSIONS

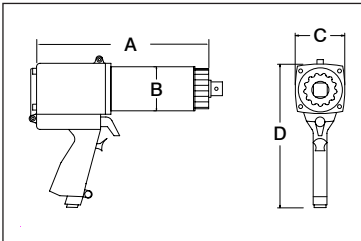

All RAD[®] Pneumatic Series tools include reaction arm, 12' hose & fittings and all new ergonomic regulator cage

PART NUMBER	TOOL MODEL	DRIVE SIZE	TORQUE (Nm)		RPM	WEIGHT (Kg)	NOISE LEVEL	DIMENSION A	DIMENSION B	DIMENSION C	DIMENSION D
			LOW	HIGH							
13539	10GX	0.75"	150	950	30	3.6	80 db	228mm	63mm	69mm	228mm
13549	14GX	0.75"	275	1350	20	3.6	80 db	228mm	63mm	69mm	228mm
13565	34GX	1.0"	1100	3400	9	6.1	85 db	246mm	77mm	83mm	241mm
13571	46GX	1.0"	1400	4600	12	9.0	85 db	325mm	86mm	93mm	264mm
15805	<i>New</i> 80DX	1.5"	2700	8000	6.6	12.5	85 db	348mm	114mm	101mm	277mm
13547	115GX	1.5"	4100	11500	4.5	17.4	85 db	431mm	120mm	127mm	279mm

Visit our website for a complete up-to-date list of products.

Accuracy of +/-5%, Repeatability of +/-2%

PNEUMATIC SERIES

RAD® WHEEL NUT BOLTING SERIES

The **RAD® WHEEL NUT BOLTING SERIES** and the **RAD® OTR MINING SERIES** were designed with one job in mind - **wheel nut bolting** for light and heavy duty applications where torque control is a must. The extended nose with available custom reaction arms make this tool ideal for reaching wheel nut studs that are recessed where tool clearance is a problem.

- ✓ Extend drive and reaction for safety and ergonomics
- ✓ Removable custom reaction arms designed to fit virtually any wheel configuration

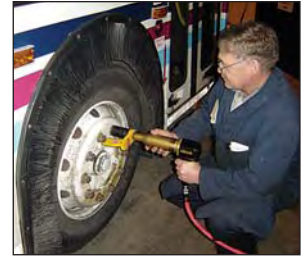

RAD® 10GX-R



Custom Reaction Arms Available

PART NUMBER	TOOL MODEL	DRIVE SIZE	TORQUE (Nm)		RPM	WEIGHT (Kg)	NOISE LEVEL	DIMENSION A	DIMENSION B	DIMENSION D	DIMENSION E
			LOW	HIGH							
13541	10GX-R	0.75"	200	950	115	5.4	80 db	368mm	63mm	69mm	228mm

RAD® OTR MINING SERIES

#1 Choice for Mines Worldwide



GX-R SERIES DIMENSIONS

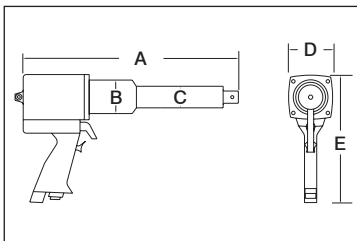

The **RAD® OTR MINING SERIES** of wheel nut bolting systems were developed exclusively for extreme duty maintenance of mining haul trucks from 50-400 ton capacities and front end loaders. The extended nose allows safe access of virtually all wheel configurations found on today's heavy equipment.



RAD® 1900NGX-R



Custom Reaction Arms Available

PART NUMBER	TOOL MODEL	DRIVE SIZE	TORQUE (Nm)		RPM	WEIGHT (Kg)	NOISE LEVEL	DIMENSION A	DIMENSION B	DIMENSION C	DIMENSION D	DIMENSION E
			LOW	HIGH								
13557	1900NGX-R	1.0"	400	1900	14	12.4	85 db	546mm	76mm	50mm	83mm	241mm
13563	2400NGX-R	1.0"	700	2450	10	12.4	85 db	546mm	76mm	50mm	83mm	241mm

Visit our website for a complete up-to-date list of products.

Accuracy of +/-5%, Repeatability of +/-2%

RAD[®] BATTERY SERIES

RAD[®] BATTERY SERIES torque wrenches offer unmatched power, versatility, and reliability. Incorporating our precision engineered gear boxes, their lightweight design makes these tools ideal for any application, especially where compressed air or electricity is not readily available. The **RAD[®] BATTERY SERIES** are available in single speed and high speed models.



Just imagine the freedom....

No Air Lines! No Power Cords! No Hassles!

Patented Extreme Duty Planetary Gear Drive

Quick Grip to Adjust Torque Setting



Easy View Torque Settings & Reference Chart

Setting	Torque	Setting	Torque
5	100	10	225
6	150	11	255
7	145	12	275
8	175	13	300
9	200	14	320
		15	335
		16	350

Cal. Date 5/4/2006 Serial #B10161
Located on gear box



All B-RAD tools come fully calibrated complete with:

- B-RAD Tool
- Reaction Arm and Retention Ring
- Two 18 volt batteries
- Battery charger
- Operators manual
- Calibration Chart
- Weatherproof Pelican Storage Case



BATTERY SERIES DIMENSIONS

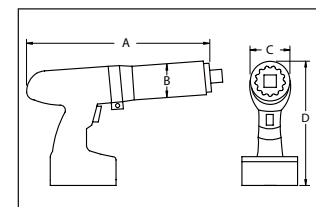

Patent Pending

PART NUMBER	TOOL MODEL	DRIVE SIZE	TORQUE (Nm)		WEIGHT (Kg)	DIMENSION A	DIMENSION B	DIMENSION C	DIMENSION D
			LOW	HIGH					
13528	B-RAD 475	0.75"	150	475	4.0	292mm	60mm	71mm	266mm
13520	B-RAD 950	0.75"	400	950	4.3	323mm	60mm	71mm	266mm
13522	B-RAD 950-2	0.75"	400	950	4.9	387mm	63mm	76mm	260mm
13524	B-RAD 1750	1.0"	550	1750	6.8	355mm	76mm	76mm	266mm
13526	B-RAD 1750-2	1.0"	550	1750	7.7	438mm	76mm	76mm	260mm

Visit our website for a complete up-to-date list of products.

BATTERY SERIES

RAD[®] E SERIES

RAD[®] E SERIES are the world's most advanced electronic pistol grip torque wrenches. They are designed to provide a high degree of accuracy and repeatability using our legendary gear box design and the precision of an electronic motor. Capable of data collection, angle measurement, accuracy of +/-3%, and torque values up to 8000 Nm, **RAD[®] E SERIES** offer an affordable solution for electronic bolting needs.

Precision Bolting Driven by Technology and Design

LIGHTER

Combining the latest advancements in ergonomic design along with an ultra-durable portable carrying case, the E Series torque system is a lightweight alternative to other bolting systems.

FASTER

Compared to other conventional torque systems, such as hydraulic wrenches, the E-RAD electronic torque system decreases tightening times by up to 60% through the delivery of continuous torque, boosting your productivity dramatically and increasing the speed of job completion.

STRONGER

With unsurpassed power-to-weight ratio and our legendary patented gearbox design, E Series tools offer the highest dependability and reliability in the industry.



- ✓ **Push-button select torque**
Fast and convenient error-free digital single increment torque settings
- ✓ **Lightweight and Ergonomic pistol grip design**
Advanced low-profile handle to reduce operator fatigue and increase productivity
- ✓ **Extremely low noise level only 75db**
World's quietest extreme torque gun, ideal for sensitive environments and standards
- ✓ **LED Green (Pass) or Red (Fail) indicator lights**
Unmistakable visual signal indicates status of torque procedure for maximum accuracy and speed
- ✓ **Data collection capability**
All E Series tools come complete with data collection software allowing traceability of each torque sequence performed



L.E.D. lights conveniently located on both sides.



Integrated Fan Kit



Forward/Reverse Trigger

ELECTRIC SERIES DIMENSIONS

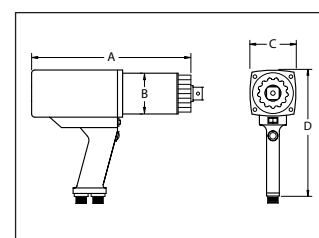

PART NUMBER	TOOL MODEL	DRIVE SIZE	TORQUE (Nm)		WEIGHT (Kg)	DIMENSION A	DIMENSION B	DIMENSION C	DIMENSION D
			LOW	HIGH					
14993	E-RAD 950	0.75"	135	950	5.4	298mm	60mm	63mm	241mm
13533	E-RAD 1600	1.0"	270	1600	6.8	323mm	76mm	82mm	241mm
13535	E-RAD 2700	1.0"	400	2700	8.1	336mm	76mm	88mm	254mm
15785	<i>New</i> E-RAD 3400 COMP	1.0"	340	3400	8.1	362mm	76mm	76mm	197mm
13537	E-RAD 4000	1.0"	675	4050	10.6	393mm	86mm	88mm	254mm
12762	E-RAD 5400	1.5"	1085	5400	14.0	423mm	101mm	101mm	197mm
15955	<i>New</i> E-RAD 8000	1.5"	2030	8100	13.0	394mm	102mm	102mm	254mm

RAD[®] E SERIES CONTROLLERS AND OPTIONS

S M - R M S - C O N - T R O L L E R

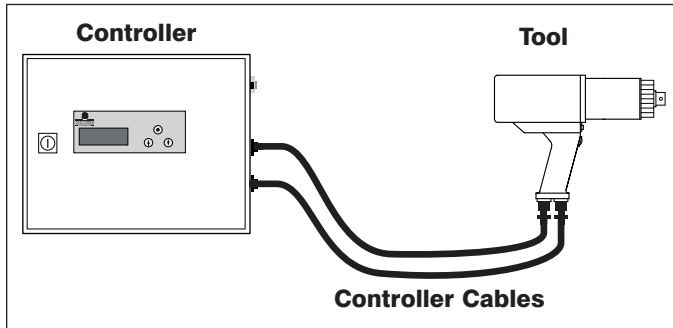

E Series controllers provide the interface for all E-RAD tools. A standard E-Series controller allows the user to dial up and down, using the touch pad, in single digit increments to their desired torque.

Option 1 - Part #13629

- ✓ User has the option to define **torque** settings
- ✓ Defined settings can be stored using an 8 channel selector switch
- ✓ All torque positions can be locked out using a removable key
- ✓ Basic data collection

Option 2 - Part #13630

- ✓ User has the option to define **torque** or **angle** or **torque and angle** sequence (1 channel)
- ✓ Tool operates as a standard E-RAD when angle is set to zero
- ✓ Basic data collection

Option 3 - Part #13631

- ✓ User has the option to define **torque** or **angle** or **torque and angle** sequence
- ✓ Defined settings can be stored using an 8 channel selector switch
- ✓ All defined settings can be locked out using a removable key
- ✓ Basic data collection

- All E Series tools come fully calibrated complete with:
- E-RAD Tool
 - Reaction Arm and Retention Ring
 - Controller cables
 - Digital Torque Controller
 - Operators manual
 - E-RADCAL Calibration Software

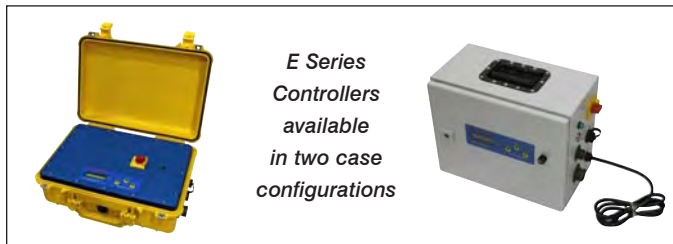

User friendly controls allow for quick torque adjustments. The backlit LCD display with three units of selectable measurement (Ft. /lbs, Nm, Kgf.m) provides optimum visibility and accuracy.

SELECT ONE OF THE FOLLOWING CONTROLLERS

PART NUMBER	DESCRIPTION	CASE TYPE	VOLTAGE	LENGTH DIMENSION	HEIGHT DIMENSION	WIDTH DIMENSION
13632	CONTROLLER	STEEL ASSEMBLY	120	378mm	300mm	203mm
13626	CONTROLLER	WEATHERPROOF ASSEMBLY	120	470mm	175mm	356mm
13627	CONTROLLER	STEEL ASSEMBLY	220	378mm	300mm	203mm
14108	CONTROLLER	WEATHERPROOF ASSEMBLY	220	470mm	175mm	356mm

SELECT ONE OF THE FOLLOWING CABLE LENGTHS

PART NUMBER	TOOL MODEL	CABLE LENGTH (M)
10984	CABLE LENGTH FROM CONTROLLER TO TOOL MODEL (standard with tool)	4.6
11845	CABLE LENGTH FROM CONTROLLER TO TOOL MODEL	6.1
11846	CABLE LENGTH FROM CONTROLLER TO TOOL MODEL	7.6

OPTIONS

PART NUMBER	DESCRIPTION	FOR USE WITH
13629	SELECTOR SWITCH WITH USER DEFINED TORQUE	ALL E-RAD'S
13630	USER DEFINED TORQUE AND ANGLE (1 CHANNEL)	ALL E-RAD'S
13631	USER DEFINED TORQUE AND ANGLE (8 CHANNEL)	ALL E-RAD'S
13628	SUPER DUTY FAN KIT	E-RAD 2700 - E-RAD 5400

Visit our website for a complete up-to-date list of products.

*E-RAD operates in standard mode if no options are selected

RAD® V SERIES

RAD® V SERIES are a new generation of electric torque wrenches used for the installation or removal of heavy duty fasteners where accuracy, power, and safety are required. This series comes without the hassle of air hoses and simply runs when plugged into any electric power supply, including generators. Based on the design of our patented planetary gear reduction system, the **RAD® V SERIES** offers a smooth continuous flow of controlled torque which is adjustable through dial settings.

- ✓ **Quick adjust torque settings**
Fast and accurate “dial a torque” for maximum versatility and efficiency
- ✓ **Soft-start vary speed trigger**
Allows operator to safely and quickly set reaction arm before full torque is applied
- ✓ **Equal power in forward and reverse**
Convenience and cost effective use of same tool for break away and final torque
- ✓ **Advanced ultra-durable electric motor design**
Extreme duty designed to reduce maintenance cost and increase reliability

Maximum versatility and efficiency...



All V-RAD tools come fully calibrated complete with:

- V-RAD Tool
- Reaction Arm and Retention Ring
- Operators manual
- Calibration Chart
- Weatherproof Storage Case

V SERIES DIMENSIONS

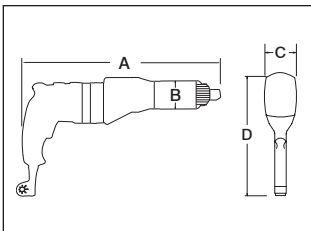

PART NUMBER	TOOL MODEL	DRIVE SIZE	TORQUE (Nm)		WEIGHT (Kg)	DIMENSION A	DIMENSION B	DIMENSION C	DIMENSION D
			LOW	HIGH					
13589	V-RAD 6	0.75"	150	550	4.5	431mm	63mm	76mm	215mm
13583	V-RAD 14	0.75"	400	1350	4.9	457mm	63mm	76mm	215mm
13585	V-RAD 21	1.0"	700	2150	6.8	482mm	76mm	76mm	215mm
13587	V-RAD 31	1.0"	1100	3100	6.8	495mm	76mm	76mm	215mm

Visit our website for a complete up-to-date list of products.

REACTION ARM SELECTION CHART



TOOL SERIES	STANDARD <i>(Included with tool)</i>	DEEP SOCKET	DOUBLE ENDED ARM	BLANK	DOUBLE ENDED BLANK
RAD 475/750	10686	10687	10688	10036	10037
RAD 1100	10043	10458	10459	10044	10045
RAD 1900/2400	10004	10007	10009	10005	10008
RAD 4000	10022	10025	10027	10024	10026
RAD 6800	10039	10401	10403	10040	10402

RAD 10/14GX	13366	13367	13368	13364	13365
RAD 34GX	10514	10515	10516	10513	10448
RAD 46GX	11531	11534	11533	11530	11532
RAD 115GX	12885	13508	13509	13505	13506

RAD 1900/2400NGX-R	13484	13515	13516	13513	13514
RAD 10GX-R	13512	12902	14135	13773	12903

*Reaction arms not exactly as shown (7GX-R, 1900NGX-R, 2400NGX-R)

B-RAD 475	10686	10687	10688	10036	10037
B-RAD 950	11460	11461	11463	11459	11462
B-RAD 1750	10004	10007	10009	10005	10008

E-RAD 950	11460	11461	11463	11459	11462
E-RAD 1600	10004	10007	10009	10005	10008
E-RAD 2700	10247	10395	10397	10394	10396
E-RAD 4000	11531	11534	11533	11530	11532

V-RAD 6	10686	10687	10688	10036	10037
V-RAD 14	13366	13367	13368	13364	13365
V-RAD 21	10004	10007	10009	10005	10008
V-RAD 31	10514	10515	10516	10513	10448

* Please contact us if you have a specific or custom application.
Our Engineering Department can design a reaction arm for all of your needs.
www.radtorque.com

Sample of Custom Reaction Arms shown below



NOSE EXTENSION SELECTION CHART



Part Number	Description	Dimension A	Dimension B	Dimension C	Dimension D
10257	RAD 2400NG 381mm Nose Extension	127mm	406mm	51mm	89mm
10258	RAD 2400NG 457mm Nose Extension	127mm	457mm	51mm	89mm
10259	RAD 2400NG 305mm Nose Extension	127mm	323mm	51mm	89mm
12087	RAD 4000 305mm Nose Extension	127mm	325mm	51mm	83mm
10734	RAD 4000 381mm Nose Extension	127mm	401mm	51mm	83mm
10735	RAD 4000 457mm Nose Extension	127mm	478mm	51mm	83mm
12061	RAD 34GX 381mm Nose Extension	127mm	406mm	51mm	83mm
12096	RAD 34GX 305mm Nose Extension	127mm	330mm	51mm	83mm
12097	RAD 34GX 457mm Nose Extension	127mm	470mm	51mm	83mm
14195	RAD 14GX 305mm Nose Extension	N/A	324mm	64mm	N/A
14200	RAD 14GX 381mm Nose Extension	N/A	400mm	64mm	N/A
14205	RAD 14GX 457mm Nose Extension	N/A	476mm	64mm	N/A

14GX Nose Extensions require a reaction arm. Refer to 10GX-R Reaction Arms on previous charts.

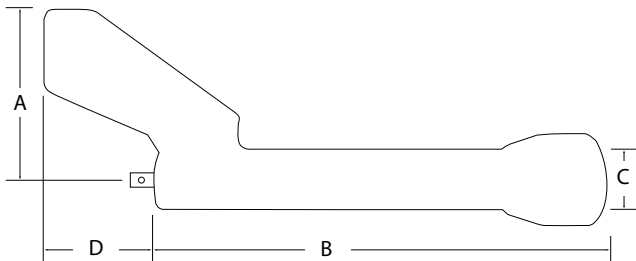

RAD 14GX (13549), 305mm nose extension (14195),
with reaction arm (13512)



Part Number
10788

RCA-3000 R
Torque Range 200-4050Nm
Accuracy +/- .25%



Part Number
10787

RCA-5000
Torque Range 700-6800Nm
Accuracy +/- .25%

RAD-CAL Digital Joint Simulating Torque Analyzers



All RAD® pneumatic torque wrenches are individually calibrated on our exclusive "RAD-CAL" dynamic joint simulator torque analyzer



Part Number
10786

RCA-3000
Torque Range 400-4050Nm
Accuracy +/- .25%



Part Number
10785

RCA-1000
Torque Range 150-1350Nm
Accuracy +/- .25%

ELECTRONIC SERIES

All E Series tools come fully calibrated complete with:

- E-RAD Tool
- Reaction Arm and Retention Ring
- Controller cables
- Digital Torque Controller
- Operators manual
- E-RADCAL Calibration Software

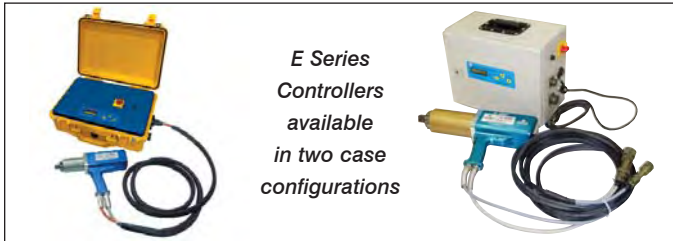

E Series
Controllers
available
in two case
configurations

E-RAD Controller with torque controls and digital display enclosed in a weatherproof case for harsh environments.

E-RAD Controller with upright heavy duty steel case, top mounted torque controls and digital display.

BATTERY SERIES



B-RAD TOOL KIT

All B-RAD tools come fully calibrated complete with

- B-RAD Tool
- Reaction Arm and Retention Ring
- Two 18 volt batteries
- Battery charger
- Operators manual
- Calibration Chart
- Weatherproof Pelican Storage Case

Part #11440



B-RAD Car Charger

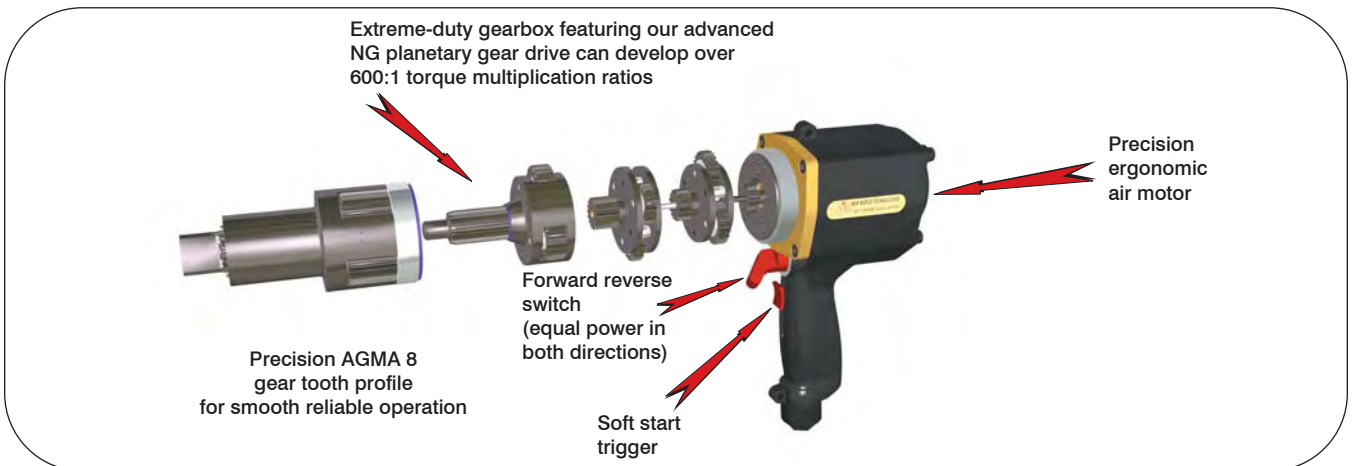

RAD® pneumatic torque wrenches incorporate our PATENTED Planetary Gear Reduction Drive Systems to produce the highest power-to-weight ratio of any pneumatic controlled bolting system in the world today!

15 YEARS INCORPORATED



New World Technologies Inc. is a leading Canadian manufacturer of pneumatic, battery powered, and electronic pistol grip torque wrenches. Our advanced products have proven to be successful all over the world in such industries as oil and gas, petrochemical, mining, aerospace, and manufacturing. We continue to invest in and employ the latest technology to achieve the highest level of innovation, quality, and performance - which has resulted in multiple patents for our products. New World Technologies Inc. has designed its operations for maximum flexibility and responsiveness ensuring our customers receive outstanding service.



- 14 CNC machining centers (Okuma and HAAS systems)
- CAD and CAM processing (Solid Works and Master Cam)
- 9 gear cutting machines (working to AGMA standards)
- 3 Professional Engineers (Mechanical and Electronics)

MAXIMUM FLEXIBILITY AND RESPONSIVENESS, ENSURING OUR CUSTOMERS RECEIVE OUTSTANDING SERVICE



Power



Highest Power-to-Weight ratio of any power tool

All RAD® torque guns are designed to deliver the highest power-to-weight ratio of any pneumatic tool on the market today, saving you time and money in maintenance or production costs. The extremely high torque and constant rotation make our tools ideal for virtually any bolting application you will encounter. Equal power in both forward and reverse allows more diversity for tough maintenance jobs.



Accuracy



Accuracy +/-5%, repeatability 2%*

Every RAD® air torque wrench is individually calibrated and traceable to NIST standards to help ensure joint integrity. Our tools are many times more accurate than impact wrenches and in many cases can be more precise than click type manual torque wrenches, which are often over pulled by operators.
* With correct air supply



Safety



88 times less vibration than Impact wrenches...Operates at only 85 db

RAD® torque guns are one of the safest power tools on the market today. Our exclusive low profile reaction arm takes virtually all the operational load off the operator, reducing injuries and greatly reducing operating costs. Don't wait for a time loss injury or legislation to force change in your environment, RAD® guns set the standard in bolting safety.



www.radtorque.com

1-800-983-0044

COMPANY PROFILE

LIGHTER • FASTER • STRONGER

Believe It!



**MINING
OIL & GAS
AEROSPACE
PETROCHEMICAL
MANUFACTURING**

