

# Boring heads

Inserts

Face milling cutters

Square shoulder cutters

Slot cutters

Porcupine cutters

Specific applications and Sets

Profile milling

Solid carbide

Drills

**Boring heads**

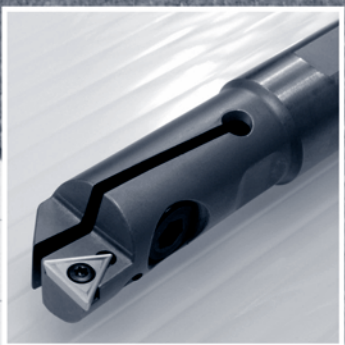

# Boring heads

Technical information	J.02
Applications	J.05
Adjustable boring bars	J.06
Special boring heads	J.08
Boring heads	J.10
Arbors for boring heads	J.18
Sets	J.21
Cutting data	J.23

Inserts

Face milling cutters

Square shoulder cutters

Slot cutters

Porcupine cutters

Specific applications and Sets

Profile milling

Solid carbide

Drills

Boring heads

## Boring heads

<b>6</b>	<b>3</b>	<b>4</b>	<b>4</b>	<b>76</b>	<b>100</b>	<b>125</b>
<b>1</b>	<b>2</b>	<b>3</b>	<b>4</b>	<b>5</b>		

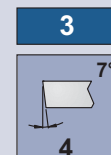
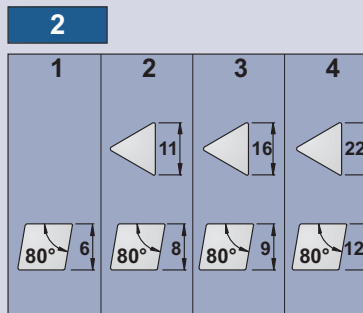
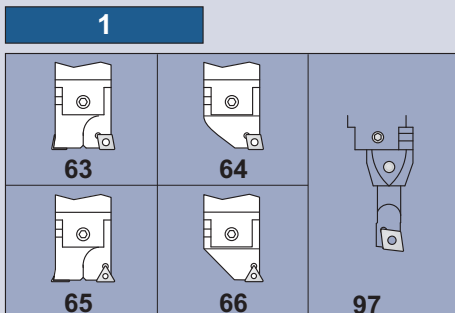

**4**

Diameter d, mm.

70	12	74	28
71	15	75	36
72	20	76	50
73	24	77	60

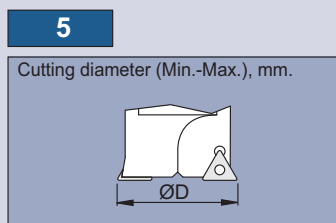

## Arbors for Boring heads

<b>60</b>	<b>43</b>	<b>70</b>	<b>35</b>
<b>1</b>	<b>2</b>	<b>3</b>	<b>4</b>

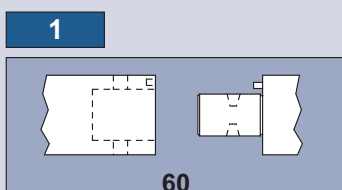

**2**

ISO		DIN 2080		ISO 7388	DIN 69871 A				
Ø16	Ø22	Ø27	Ø32	Ø40	ISO 30	ISO 40	ISO 50	7388 40	7388 50
<b>16</b>	<b>22</b>	<b>27</b>	<b>32</b>	<b>40</b>	<b>43</b>	<b>44</b>	<b>45</b>	<b>47</b>	<b>48</b>
ISO		BT System							
BT 40	BT 50	Ø25	Ø32	Ø40	Ø22	Ø27	Ø32	Ø42	
<b>49</b>	<b>50</b>	<b>62</b>	<b>63</b>	<b>64</b>	<b>70</b>	<b>71</b>	<b>72</b>	<b>73</b>	

**3**

Diameter d, mm

70	12	74	28
71	15	75	36
72	20	76	50
73	24	77	60

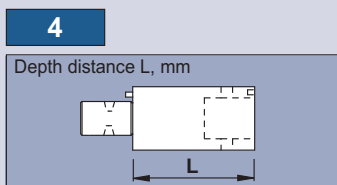

## Tools for Boring heads

<b>S</b>	<b>08</b>	<b>16</b>	<b>F</b>	<b>S</b>	<b>C</b>	<b>L</b>	<b>C</b>	<b>R</b>	<b>06</b>
<b>1</b>	<b>2</b>	<b>3</b>	<b>4</b>	<b>5</b>	<b>6</b>	<b>7</b>	<b>8</b>	<b>9</b>	<b>10</b>

**1**

**Type of bar**

<b>A</b> Steel shank with coolant hole
<b>H</b> Heavy metal
<b>J</b> Heavy metal with coolant hole
<b>S</b> Steel shank

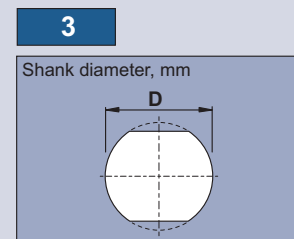
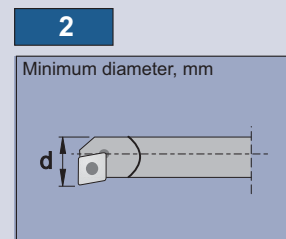

**4**

Bar length, mm

<b>E</b> 70	<b>I</b> 110
<b>F</b> 80	<b>J</b> 115
<b>G</b> 90	<b>X</b> Special
<b>H</b> 100	

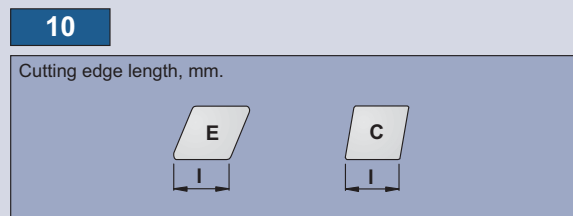
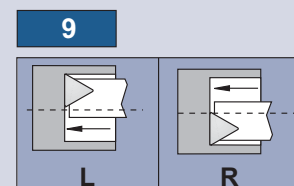
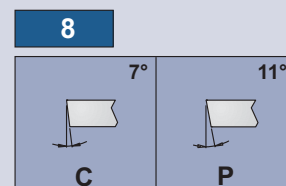
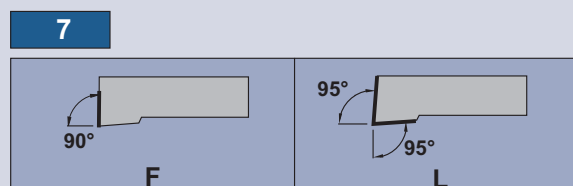
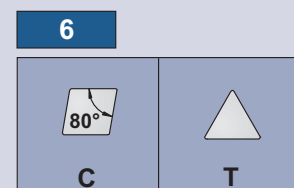

Inserts

Face milling  
cuttersSquare shoulder  
cutters

Slot cutters

Porcupine cutters

Specific applications  
and Sets

Profile milling

Solid carbide

Drills

Boring heads

## Boring heads

The boring heads are made of Nickel-Chrome alloy steel, with a core toughness of 113,786 to 128,000 lbs/in<sup>2</sup>.

All the component parts of the head are heat treated to prolong life and minimise wear on moving parts.

The slides are precision ground and close tolerances are maintained in order that the heads provide and maintain accuracy of adjustment throughout their working life.

The micrometer adjusting screw of the "finishing heads" has a ground precision thread.

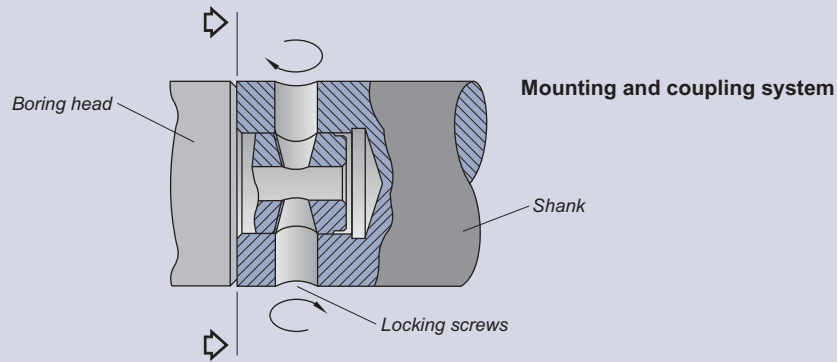

Adjustable boring bar

<p><b>6114.07</b> Adjustable boring bar</p>  <p>CC.. 0602.. TC.. 1102.. TC.. 16T3..</p> <p>Page J.06</p>					
---	--	--	--	--	--

Special boring heads

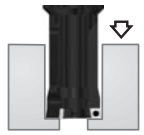
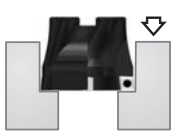
<p><b>4334.07</b> Special boring head</p>  <p>Page J.08</p> <p>CC.. 09T3..</p>	<p><b>4334.90</b> Special boring head</p>  <p>Page J.09</p> <p>CC.. 09T3.. CC.. 1204..</p>				
---	---	--	--	--	--

Boring heads

<p><b>97.73</b> Boring head</p>  <p>Page J.10</p>	<p><b>SCLC</b> Tools for boring heads</p>  <p>Page J.11</p> <p>CC.. 0602.. CC.. 09T3..</p>	<p><b>STFC</b> Tools for boring heads</p>  <p>Page J.11</p> <p>TC.. 0602.. TC.. 09T3.. TC.. 1604..</p>			
<p><b>6314.74</b> Roughing boring heads</p>  <p>Page J.12</p> <p>CC.. 0602.. CC.. 09T3.. CC.. 1204..</p>	<p><b>6344.79</b> Roughing boring heads</p>  <p>Page J.13</p> <p>CC.. 1204..</p>	<p><b>6414.74</b> Finishing boring heads</p>  <p>Page J.14</p> <p>CC.. 0602.. CC.. 09T3.. CC.. 1204..</p>	<p><b>6444.79</b> Finishing boring heads</p>  <p>Page J.15</p> <p>CC.. 1204..</p>	<p><b>6634.74</b> Finishing boring heads</p>  <p>Page J.16</p> <p>TC.. 16T3..</p>	<p><b>6634.79</b> Finishing boring heads</p>  <p>Page J.17</p> <p>TC.. 16T3..</p>

Arbors for boring heads

<p><b>60.43</b> DIN 2080 Arbors for boring heads</p>  <p>Page J.18</p>	<p><b>60.47</b> DIN 69871/A Arbors for boring heads</p>  <p>Page J.18</p>	<p><b>60.49</b> MAS BT Arbors for boring heads</p>  <p>Page J.19</p>	<p><b>60.62</b> Arbors for boring heads</p>  <p>Page J.20</p>	<p><b>60.79</b> Arbors for boring heads</p>  <p>Page J.20</p>	
---	--	---	---	--	--

Sets

<p><b>SET 97</b></p>  <p>Page J.21</p>	<p><b>SET 7072</b></p>  <p>Page J.22</p>	<p><b>SET 7074</b></p>  <p>Page J.22</p>			
---	---	---	--	--	--



Inserts

Face milling cutters

Square shoulder cutters

Slot cutters

Porcupine cutters

Specific applications and Sets

Profile milling

Solid carbide

Drills

Boring heads

**Characteristics:**  
Adjustable boring bars.

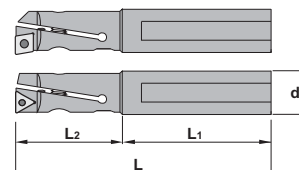
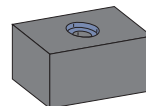
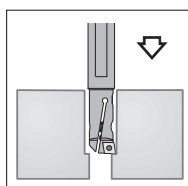

## 6114.07

Ref.	L	L1	L2	d	Dmin	Dmax	Insert size	kg
6114.07.012	105	70	35	12	12	15	CC.. 0602..	0,800
6114.07.015	110	60	50	16	15	20	CC.. 0602..	1,100
6114.07.020	120	60	60	20	20	25	TC.. 1102..	1,600
6114.07.025	140	70	70	25	25	30	TC.. 16T3..	2,800
6114.07.030	160	70	90	25	30	35	TC.. 16T3..	3,600

Ref.	1550	1503	1425	-	5015	5520	5507
6114.07.012	1550	1503	1425	-	5015	5520	5507
6114.07.015	1261	1504	1425	-	5002	5525	5507
6114.07.020	1182	1505	1225	1505	5025	5525	5507
6114.07.025	1182	1515	1240	1515	5025	5525	5515
6114.07.030	1182	1515	1240	1515	5025	5525	5515

Ref.	CC.. / TC..			Positive 7° clearance - 80° rhombic inserts.
	l	s	d	
CC.. 0602..	6,45	2,38	6,35	Positive 7° clearance - Triangular inserts
TC.. 1102..	11,00	2,38	6,35	
TC.. 16T3..	16,50	3,97	9,52	

CCGT-AL	CCMT-03	CCMW	TCGT-AL	TCMT-03	TCMT-39	TCMW

For more information see page: A.12 / A.19





Inserts

Face milling cutters

Square shoulder cutters

Slot cutters

Porcupine cutters

Specific applications and Sets

Profile milling

Solid carbide

Drills

Boring heads

**Characteristics:**  
Roughing boring heads.

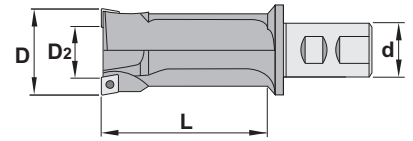
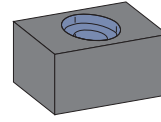
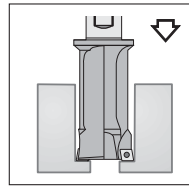

### 4334.07

Ref.			D	D2	d	L	Insert size	
4334.07.040		3	40	20	25	105	CC.. 09T3..	2,700
4334.07.045		3	45	25	25	105	CC.. 09T3..	3,000
4334.07.050		3	50	30	25	105	CC.. 09T3..	3,400
4334.07.055		3	55	35	25	105	CC.. 09T3..	3,700



Ref.		1240	5615
4334.07.040		1240	5615
4334.07.045		1240	5615
4334.07.050		1240	5615
4334.07.055		1240	5615

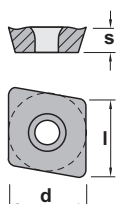

#### CC..

Ref.	CC.. 09T3..	l	s	d
		9,65	3,97	9,52

Positive 7° clearance - 80° rhombic inserts.

For more information see page: A.12

CCGT-AL

CCKT

CCMW





**Characteristics:**  
Roughing boring heads.

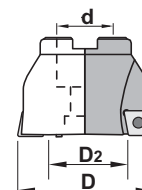
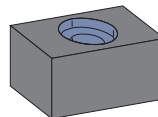
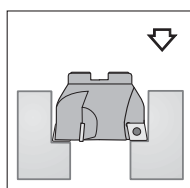

## 4334.90

Ref.		D	D2	d	Insert size	
4334.90.060	3	60	40	16	CC.. 09T3..	0,000
4334.90.065	3	65	45	22	CC.. 09T3..	
4334.90.070	3	70	50	22	CC.. 09T3..	
4334.90.075	3	75	55	27	CC.. 1204..	
4334.90.080	3	80	60	27	CC.. 1204..	
4334.90.085	3	85	65	32	CC.. 1204..	
4334.90.090	3	90	70	32	CC.. 1204..	
4334.90.095	3	95	75	32	CC.. 1204..	
4334.90.100	3	100	80	32	CC.. 1204..	
4334.90.105	3	105	85	40	CC.. 1204..	
4334.90.110	3	110	90	40	CC.. 1204..	
4334.90.115	3	115	95	40	CC.. 1204..	
4334.90.120	3	120	100	40	CC.. 1204..	
4334.90.125	3	125	105	40	CC.. 1204..	
4334.90.130	3	130	110	40	CC.. 1204..	
4334.90.135	3	135	115	40	CC.. 1204..	
4334.90.140	3	140	120	40	CC.. 1204..	
4334.90.145	3	145	125	40	CC.. 1204..	
4334.90.150	3	150	130	40	CC.. 1204..	
4334.90.155	3	155	135	40	CC.. 1204..	

Ref.		
4334.90.060	1240	5615
4334.90.065	1240	5615
4334.90.070	1240	5615
4334.90.075	1250	5620
4334.90.080	1250	5620
4334.90.085	1250	5620
4334.90.090	1250	5620
4334.90.095	1250	5620
4334.90.100	1250	5620
4334.90.105	1250	5620
4334.90.110	1250	5620
4334.90.115	1250	5620
4334.90.120	1250	5620
4334.90.125	1250	5620
4334.90.130	1250	5620
4334.90.135	1250	5620
4334.90.140	1250	5620
4334.90.145	1250	5620
4334.90.150	1250	5620
4334.90.155	1250	5620

Ref.	CC..			Positive 7° clearance - 80° rhombic inserts.
	l	s	d	
CC.. 09T3..	9,65	3,97	9,52	For more information see page: A.12
CC.. 1204..	12,90	4,76	12,70	
<b>CCGT-AL</b>	<b>CCKT</b>	<b>CCMW</b>		

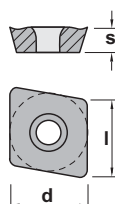

Inserts

Face milling cutters

Square shoulder cutters

Slot cutters

Porcupine cutters

Specific applications and Sets

Profile milling

Solid carbide

Drills

Boring heads



**Characteristics:**

Graduated dial, read-out precision 0,01 mm. Ø

**Applications:**

Finishing boring heads.

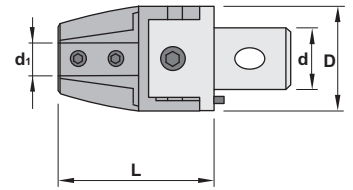

97.71 97.73		D	L	d	d1	Dmin	Dmax	kg
Ref.	97.71.08	27	50	15	8	10	21	0,170
	97.72.08	32	58	20	8	10	21	0,280
	97.72.10	32	58	20	10	13	25	0,290
	97.73.10	42	70	24	10	13	29	0,650
	97.73.12	42	70	24	12	16	34	0,620
	97.73.16	42	70	24	16	20	38	0,600

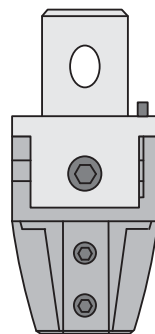

97..

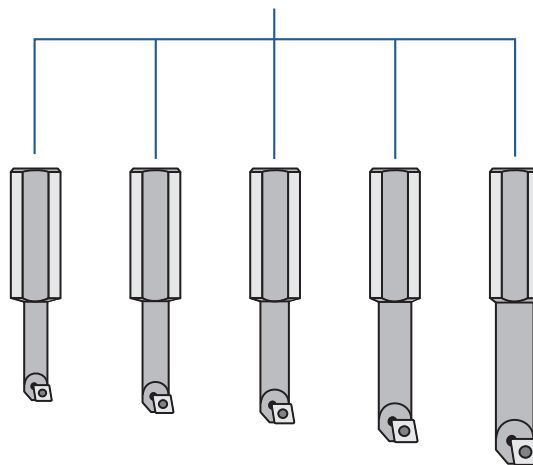

SCLC/STFC



**Characteristics:**  
Tool equipped with rhombic positive insert (angle 80°).  
The center screw ensures good rigidity and chip flow.

**Applications:**  
Tool for boring heads.

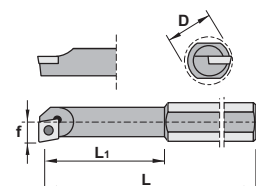
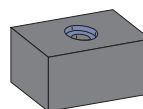
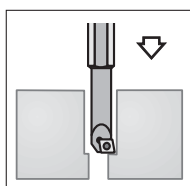

<b>SCLC</b>											
		D	L	L1	f	Bore Range		Inserts			
Ref.						min	max		Kg		
	<b>S0816F SCLC R 06</b>	16	80	35	4	10	28	CC.. 0602..	0,070	1425	5507
	<b>S1016G SCLC R 06</b>	16	90	45	6	13	31	CC.. 0602..	0,100	1425	5507
	<b>S1216H SCLC R 06</b>	16	100	57	7	16	34	CC.. 0602..	0,100	1425	5507
	<b>S1616I SCLC R 09</b>	16	110	73	9	20	38	CC.. 09T3..	0,150	1440	5515

	<b>CC..</b>				Positive 7° clearance - 80° rhombic inserts.
	Ref.	l	s	d	
	CC.. 0602..	6,45	2,38	6,35	
CC.. 09T3..	9,65	3,97	9,52		

For more information see page: A.12

CCGT-AL	CCMT-03	CCMW			



**Characteristics:**  
Tool equipped with triangular positive insert.  
The center screw ensures good rigidity and chip flow.

**Applications:**  
Tool for boring heads.

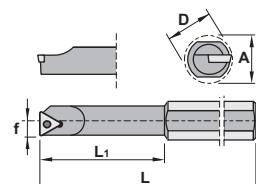
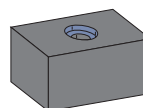
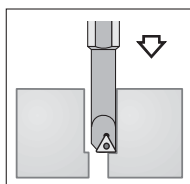

<b>STFC</b>											
		D	L	L1	f	Bore Range		Inserts			
Ref.						min	max		Kg		
	<b>S0816F STFC R 09</b>	16	80	35	5	10	28	TC.. 0902..	0,090	1222	5506
	<b>S1016G STFC R 09</b>	16	90	45	6	13	31	TC.. 0902..	0,100	1222	5506
	<b>S1216H STFC R 09</b>	16	100	57	7	16	34	TC.. 0902..	0,100	1222	5506
	<b>S1616I STFC R 09</b>	16	110	73	9	20	38	TC.. 0902..	0,100	1222	5506
	<b>S1616I STFC R 16</b>	16	110	73	11	20	38	TC.. 16T3..	0,150	1425	5515

	<b>TC..</b>				Positive 7° clearance - Triangular inserts
	Ref.	l	s	d	
	TC.. 0902..	9,62	2,38	5,55	
TC.. 16T3..	16,50	3,97	9,52		

For more information see page: A.20

TCGT-AL	TCMT-03	TCMT-39	TCMW		



Inserts

Face milling cutters

Square shoulder cutters

Slot cutters

Porcupine cutters

Specific applications and Sets

Profile milling

Solid carbide

Drills

Boring heads

**Characteristics:**  
Roughing boring heads.

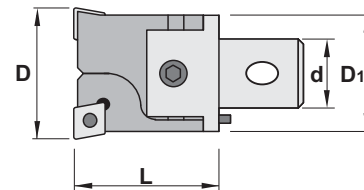
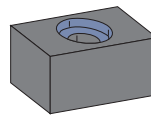
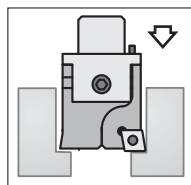

**63<sup>1</sup><sub>4</sub> 4.<sup>70</sup><sub>74</sub>**

Ref.		D <sub>1</sub>	L	d	D <sub>min</sub>	D <sub>max</sub>	Insert size	kg
6314.70.2430		22	34	12	24	30	CC.. 0602..	0,075
6334.71.2940		27	42	15	29	40	CC.. 09T3..	0,150
6334.72.3950		32	45	20	39	50	CC.. 09T3..	0,250
6344.73.4965		42	56	24	49	65	CC.. 1204..	0,500
6344.74.6382		54	56	28	63	82	CC.. 1204..	1,000

Ref.				
6314.70.2430	1425	5607	5003	5002
6334.71.2940	1240	5615	5004	5002
6334.72.3950	1240	5615	5004	5025
6344.73.4965	1250	5620	5005	5003
6344.74.6382	1250	5620	5006	5003

Ref.	CC..	l	s	d	
CC.. 0602..		6,45	2,38	6,35	Positive 7° clearance - 80° rhombic inserts.
CC.. 09T3..		9,65	3,97	9,52	
CC.. 1204..		12,90	4,76	12,70	
	CCGT-AL	CCMT-03	CCMW		For more information see page: A.12

**Characteristics:**  
Roughing boring heads.

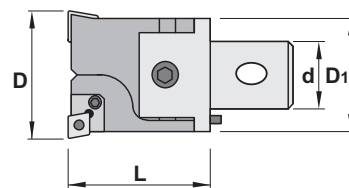
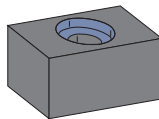
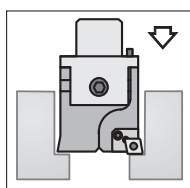

**6344.<sup>75</sup><sub>77</sub>**

Ref.		D <sub>1</sub>	L	d	D <sub>min</sub>	D <sub>max</sub>	Insert size	Kg
6344.75.080102		68	86	36	80	102	CC.. 1204..	2,200
6344.76.100125		85	100	50	100	125	CC.. 1204..	4,000
6344.77.125160		110	100	60	125	160	CC.. 1204..	6,550
6344.77.160220		145	100	60	160	220	CC.. 1204..	8,700

Ref.					
6344.75.080102	1250	5620	5508	5004	6412
6344.76.100125	1250	5620	5508	5005	6412
6344.77.125160	1250	5620	5508	5005	6412
6344.77.160220	1250	5620	5508	5005	6412

 	CC..				Positive 7° clearance - 80° rhombic inserts.
	Ref.	CC.. 1204..	l	s	
			12,90	4,76	12,70
	CCGT-AL	CCMT-03	CCMW		

For more information see page: A.12

Inserts

Face milling cutters

Square shoulder cutters

Slot cutters

Porcupine cutters

Specific applications and Sets

Profile milling

Solid carbide

Drills

Boring heads



**Characteristics:**

Graduated dial, read-out precision 0,01 mm. Ø

**Applications:**

Finishing boring heads.

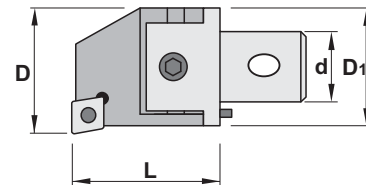
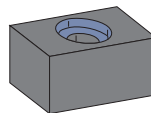
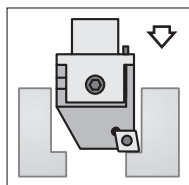

64 <sup>1</sup> <sub>4</sub> 4. <sup>70</sup> <sub>74</sub>		D <sub>1</sub>	L	d	D <sub>min</sub>	D <sub>max</sub>	Insert size	kg
Ref.	6414.70.2430	22	34	12	24	30	CC.. 0602..	0,075
	6434.71.2940	27	42	15	29	40	CC.. 09T3..	0,150
	6434.72.3950	32	45	20	39	50	CC.. 09T3..	0,250
	6444.73.4965	42	56	24	49	65	CC.. 1204..	0,450
	6444.74.6382	54	66	28	63	82	CC.. 1204..	0,900

Ref.	6414.70.2430	6434.71.2940	6434.72.3950	6444.73.4965	6444.74.6382
	1425	1240	1240	1250	1250
	5607	5615	5615	5620	5620
	5003	5004	5004	5005	5006
	5002	5002	5025	5003	5003

Ref.	CC..	l	s	d	
	CC.. 0602..	6,45	2,38	6,35	Positive 7° clearance - 80° rhombic inserts.
	CC.. 09T3..	9,65	3,97	9,52	
	CC.. 1204..	12,90	4,76	12,70	
	CCGT-AL	CCMT-03	CCMW		For more information see page: A.12





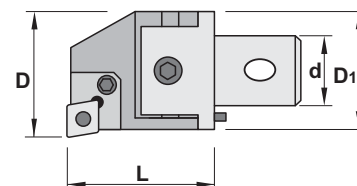
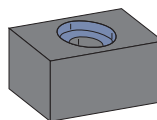
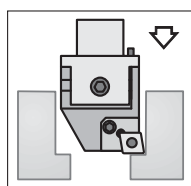

**Characteristics:**  
Graduated dial, read-out precision 0,01 mm. Ø





**Applications:**  
Finishing boring heads.

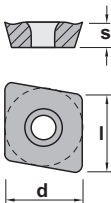

**6444.75**  
**77**

Ref.		D1	L	d	Dmin	Dmax	Insert size	kg
6444.75.080102		68	86	36	80	102	CC.. 1204..	2,050
6444.76.100125		85	100	50	100	125	CC.. 1204..	3,700
6444.77.125160		110	100	60	125	160	CC.. 1204..	6,150
6444.77.160220		145	100	60	160	220	CC.. 1204..	8,050

Ref.						
6444.75.080102		1250	5620	5508	5004	6412
6444.76.100125		1250	5620	5508	5005	6412
6444.77.125160		1250	5620	5508	5005	6412
6444.77.160220		1250	5620	5508	5005	6412

	CC..				Positive 7° clearance - 80° rhombic inserts.
	Ref.	CC.. 1204..	l	s	
			12,90	4,76	12,70
	CCGT-AL	CCMT-03	CCMW		
					

For more information see page: A.12



Inserts

Face milling cutters

Square shoulder cutters

Slot cutters

Porcupine cutters

Specific applications and Sets

Profile milling

Solid carbide

Drills

Boring heads



**Characteristics:**

Graduated dial, read-out precision 0,01 mm. Ø



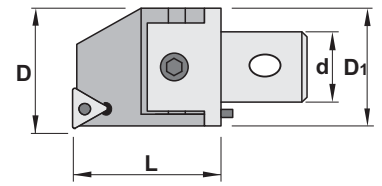
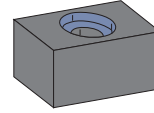
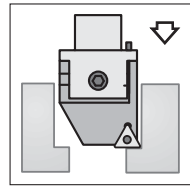

**Applications:**





Finishing boring heads.



## 6634.72 6634.74

Ref.		D1	L	d	Dmin	Dmax	Insert size	kg
6634.72.3950		32	45	20	39	50	TC.. 16T3..	0,250
6634.73.4965		42	56	24	49	65	TC.. 16T3..	0,450
6634.74.6382		54	66	28	63	82	TC.. 16T3..	0,900

Ref.					
6634.72.3950		1240	5615	5004	5025
6634.73.4965		1250	5620	5005	5003
6634.74.6382		1250	5620	5006	5003

TC..		l	s	d	Positive 7° clearance - Triangular inserts
Ref.	TC.. 16T3..	16,50	3,97	9,52	
For more information see page: A.20					
TCGT-AL	TCMT-03	TCMT-39	TCMW		
					

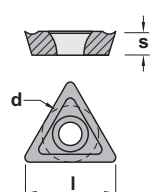



**Characteristics:**

Graduated dial, read-out precision 0,01 mm. Ø

**Applications:**

Finishing boring heads.

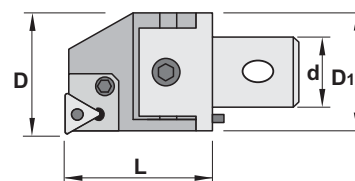
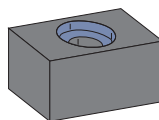
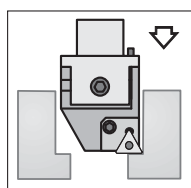

**6634.75**  
**77**

Ref.		D1	L	d	Dmin	Dmax	Insert size	Kg
6634.75.080102		68	86	36	80	102	TC.. 16T3..	2,050
6634.76.100125		85	100	50	100	125	TC.. 16T3..	3,700
6634.77.125160		110	100	60	125	160	TC.. 16T3..	6,150
6634.77.160220		145	100	60	160	220	TC.. 16T3..	8,050

Ref.					
6634.75.080102	1250	5620	5508	5004	6412
6634.76.100125	1250	5620	5508	5005	6412
6634.77.125160	1250	5620	5508	5005	6412
6634.77.160220	1250	5620	5508	5005	6412

	TC..				Positive 7° clearance - Triangular inserts
	Ref.	l	s	d	
	TC.. 16T3..	16,50	3,97	9,52	
	TCGT-AL	TCMT-03	TCMT-39	TCMW	

For more information see page: A.20

Inserts

Face milling cutters

Square shoulder cutters

Slot cutters

Porcupine cutters

Specific applications and Sets

Profile milling

Solid carbide

Drills

Boring heads



**Characteristics:**  
Arbors for boring heads.

**DIN 2080**

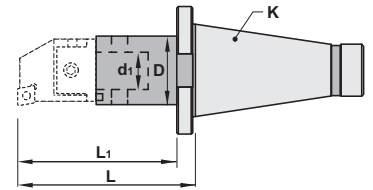
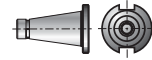

60.43 60.45		K	D	L	L1	d1	kg
Ref.	60.43.70.100	30	22	115	100	12	0,450
	60.43.71.100	30	27	115	100	15	0,550
	60.43.72.100	30	32	115	100	20	0,600
	60.44.70.100	40	22	115	100	12	0,950
	60.44.71.100	40	27	115	100	15	1,050
	60.44.72.100	40	32	115	100	20	1,100
	60.44.73.160	40	42	175	160	24	1,850
	60.44.74.160	40	54	175	160	28	2,300
	60.44.75.160	40	68	176	160	36	2,500
	60.45.70.100	50	22	119	100	12	2,850
	60.45.71.100	50	27	119	100	15	2,900
	60.45.72.130	50	32	149	130	20	3,150
	60.45.73.160	50	42	179	160	24	3,700
	60.45.74.160	50	54	179	160	28	4,250
	60.45.75.200	50	68	220	200	36	5,650
	60.45.76.200	50	85	221	200	50	6,350
	60.45.77.260	50	100	281	260	60	11,000



**Characteristics:**  
Arbors for boring heads.

**DIN 69871/A**

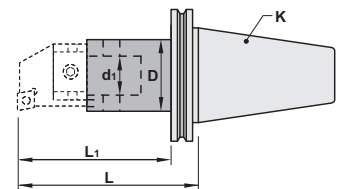
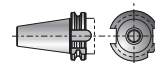

60.47 60.48		K	D	L	L1	d1	kg
Ref.	60.47.70.100	40	22	115	100	12	1,200
	60.47.71.100	40	27	115	100	15	1,250
	60.47.72.100	40	32	115	100	20	1,500
	60.47.73.160	40	42	175	160	24	1,900
	60.47.74.160	40	54	175	160	28	2,300
	60.47.75.160	40	68	176	160	36	2,600
	60.48.70.100	50	22	119	100	12	3,350
	60.48.71.100	50	27	119	100	15	3,400
	60.48.72.130	50	32	149	130	20	3,600
	60.48.73.160	50	42	179	160	24	4,200
	60.48.74.160	50	54	179	160	28	4,700
	60.48.75.200	50	68	220	200	36	5,650
	60.48.76.200	50	85	221	200	50	6,200
	60.48.77.260	50	100	281	260	60	10,850



**Characteristics:**  
Arbors for boring heads.

MAS BT

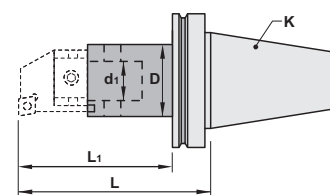
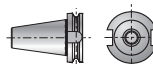

60.<sup>49</sup>/<sub>50</sub>

Ref.		K	D	L	L1	d1	
60.49.70.100		40	22	115	100	12	1,200
60.49.71.100		40	27	115	100	15	1,250
60.49.72.100		40	32	115	100	20	1,600
60.49.73.160		40	42	175	160	24	2,050
60.49.74.160		40	54	175	160	28	2,550
60.49.75.160		40	68	176	160	36	2,550
60.50.70.100		50	22	119	100	12	3,850
60.50.71.100		50	27	119	100	15	3,950
60.50.72.130		50	32	149	130	20	4,200
60.50.73.160		50	42	179	160	24	5,200
60.50.74.160		50	54	179	160	28	5,800
60.50.75.200		50	68	220	200	36	6,650
60.50.76.200		50	85	221	200	50	7,400
60.50.77.260		50	100	281	260	60	12,300



Inserts

Face milling cutters

Square shoulder cutters

Slot cutters

Porcupine cutters

Specific applications and Sets

Profile milling

Solid carbide

Drills

Boring heads



**Characteristics:**  
Arbors for boring heads.

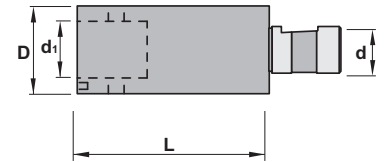

<b>60. <sup>62</sup>/<sub>64</sub></b>		<b>D</b>	<b>d</b>	<b>L</b>	<b>d1</b>	<b>kg</b>
Ref.	60.62.70	22	20	20	12	0,050
	60.62.71	27	20	30	15	0,100
	60.63.70	22	20	30	12	0,120
	60.63.71	27	20	45	15	0,230
	60.63.72	32	25	35	20	0,320
	60.64.70	22	20	52	12	0,210
	60.64.71	27	20	52	15	0,290
	60.64.72	32	20	52	20	0,400
	60.64.73	42	25	60	24	0,500



**Characteristics:**  
Arbors for boring heads.

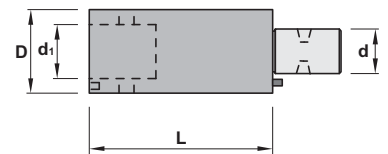

<b>60. <sup>70</sup>/<sub>73</sub></b>		<b>D</b>	<b>d</b>	<b>L</b>	<b>d1</b>	<b>kg</b>
Ref.	60.70.70.20	22	12	20	12	0,050
	60.70.70.30	22	12	30	12	0,100
	60.71.71.30	27	15	30	15	0,130
	60.71.71.45	27	15	45	15	0,190
	60.72.72.35	32	20	35	20	0,200
	60.72.72.52	32	20	52	20	0,270
	60.73.73.40	42	24	40	24	0,400
	60.73.73.60	42	24	60	24	0,600



**Applications:**  
Roughing boring heads.

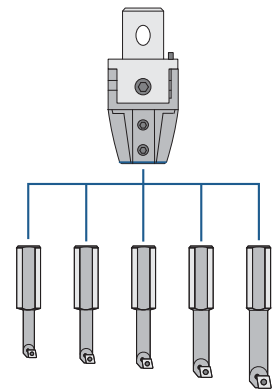

SET 97		Boring head	Boring bars	Bore Range	
				min	max
Ref.	97.SCLC	97.73.16	S0816F SCLC R 06	10	28
			S1016G SCLC R 06	13	31
			S1216H SCLC R 06	16	34
			S1616I SCLC R 09	20	38
	97.STFC	97.73.16	S0816F STFC R 09	10	28
			S1016G STFC R 09	13	31
			S1216H STFC R 09	16	34
			S1616I STFC R 09	20	38
			S1616I STFC R 16	20	38

Inserts

Face milling cutters

Square shoulder cutters

Slot cutters

Porcupine cutters

Specific applications and Sets

Profile milling

Solid carbide

Drills

Boring heads



**Applications:**  
Roughing and finishing boring heads.

<b>SET 7072</b>		Roughing boring head	Finishing boring head	Boring head	Boring bars	Bore Range	
Ref.	SET 7072					min	max
		6314.70.2430	6414.70.2430	97.73.16	S0816F SCLC R 06	10	28
		6334.71.2940	6434.71.2940		S1016G SCLC R 06	13	31
		6334.72.3950	6434.72.3950		S1216H SCLC R 06	16	34
					S1616I SCLC R 09	20	38



**Applications:**  
Roughing and finishing boring heads.

<b>SET 7074</b>		Roughing boring head	Finishing boring head	Boring head	Boring bars	Bore Range	
Ref.	SET 7074					min	max
		6314.70.2430	6414.70.2430	97.73.16	S0816F SCLC R 06	10	28
		6334.71.2940	6434.71.2940		S1016G SCLC R 06	13	31
		6334.72.3950	6434.72.3950		S1216H SCLC R 06	16	34
		6344.73.4965	6444.73.4965				
		6344.74.6382	6444.74.6382		S1616I SCLC R 09	20	38

## Cutting data for boring heads

Material	Head size	Diameter	Finishing heads			Roughing heads		
			Cutting Speed	Feed	Cutting Depth	Cutting Speed	Feed	Cutting Depth (max)
Plain carbon steel	22	24 ÷ 30	110 - 140	0,05 - 0,15	0,05 - 0,30	100 - 130	0,15 - 0,25	4,2
	27	29 ÷ 40	115 - 150	0,05 - 0,15	0,05 - 0,30	105 - 140	0,15 - 0,30	5,7
	32	39 ÷ 50	115 - 150	0,05 - 0,15	0,06 - 0,35	105 - 150	0,20 - 0,30	5,7
	42 - 54 - 68	49 ÷ 102	115 - 150	0,10 - 0,20	0,06 - 0,35	105 - 150	0,25 - 0,35	6,3
	85 - 110 - 145	100 ÷ 220	115 - 150	0,10 - 0,20	0,07 - 0,50	105 - 150	0,30 - 0,40	6,3
Alloy steels	22	24 ÷ 30	100 - 130	0,05 - 0,15	0,05 - 0,30	90 - 120	0,15 - 0,25	4,2
	27	29 ÷ 40	110 - 140	0,05 - 0,15	0,05 - 0,30	100 - 130	0,15 - 0,30	5,7
	32	39 ÷ 50	110 - 150	0,05 - 0,15	0,06 - 0,35	100 - 130	0,20 - 0,30	5,7
	42 - 54 - 68	49 ÷ 102	110 - 150	0,10 - 0,20	0,06 - 0,35	100 - 130	0,25 - 0,35	6,3
	85 - 110 - 145	100 ÷ 220	110 - 150	0,10 - 0,20	0,07 - 0,50	100 - 130	0,30 - 0,40	6,3
Stainless steels	22	24 ÷ 30	70 - 100	0,07 - 0,15	0,12 - 0,35	60 - 90	0,12 - 0,20	4,2
	27	29 ÷ 40	80 - 110	0,07 - 0,15	0,12 - 0,35	70 - 100	0,15 - 0,25	5,7
	32	39 ÷ 50	80 - 110	0,07 - 0,15	0,20 - 0,50	70 - 100	0,15 - 0,25	5,7
	42 - 54 - 68	49 ÷ 102	80 - 110	0,10 - 0,20	0,20 - 0,50	70 - 100	0,20 - 0,30	6,3
	85 - 110 - 145	100 ÷ 220	80 - 110	0,12 - 0,20	0,25 - 0,75	70 - 100	0,25 - 0,35	6,3
Cast iron	22	24 ÷ 30	70 - 110	0,07 - 0,15	0,12 - 0,35	60 - 110	0,20 - 0,30	4,2
	27	29 ÷ 40	80 - 115	0,07 - 0,15	0,12 - 0,35	60 - 110	0,25 - 0,35	5,7
	32	39 ÷ 50	80 - 115	0,07 - 0,15	0,20 - 0,50	60 - 110	0,25 - 0,35	5,7
	42 - 54 - 68	49 ÷ 102	80 - 115	0,12 - 0,20	0,20 - 0,50	60 - 110	0,30 - 0,45	6,3
	85 - 110 - 145	100 ÷ 220	80 - 115	0,12 - 0,20	0,25 - 0,75	60 - 110	0,30 - 0,45	6,3
Aluminium and aluminium alloys	22	24 ÷ 30	150 - 300	0,05 - 0,15	0,12 - 0,35	120 - 300	0,20 - 0,30	4,2
	27	29 ÷ 40	150 - 360	0,10 - 0,20	0,12 - 0,35	150 - 370	0,25 - 0,35	5,7
	32	39 ÷ 50	150 - 360	0,10 - 0,20	0,20 - 0,50	150 - 370	0,25 - 0,35	5,7
	42 - 54 - 68	49 ÷ 102	150 - 360	0,10 - 0,20	0,20 - 0,50	150 - 370	0,30 - 0,45	6,3
	85 - 110 - 145	100 ÷ 220	150 - 360	0,10 - 0,25	0,25 - 0,75	150 - 370	0,30 - 0,45	6,3
Titanium	22	24 ÷ 30	30 - 40	0,07 - 0,15	0,12 - 0,35	25 - 35	0,12 - 0,20	4,2
	27	29 ÷ 40	30 - 45	0,07 - 0,15	0,12 - 0,35	30 - 40	0,15 - 0,25	5,7
	32	39 ÷ 50	30 - 45	0,07 - 0,15	0,20 - 0,50	30 - 40	0,15 - 0,25	5,7
	42 - 54 - 68	49 ÷ 102	30 - 45	0,10 - 0,20	0,20 - 0,50	30 - 40	0,20 - 0,30	6,3
	85 - 110 - 145	100 ÷ 220	30 - 45	0,10 - 0,20	0,25 - 0,75	30 - 40	0,20 - 0,35	6,3
High tempered alloys	22	24 ÷ 30	30 - 40	0,07 - 0,15	0,12 - 0,35	25 - 35	0,12 - 0,20	4,2
	27	29 ÷ 40	30 - 45	0,07 - 0,15	0,12 - 0,35	30 - 40	0,15 - 0,25	5,7
	32	39 ÷ 50	30 - 45	0,07 - 0,15	0,20 - 0,50	30 - 40	0,15 - 0,25	5,7
	42 - 54 - 68	49 ÷ 102	30 - 45	0,10 - 0,20	0,20 - 0,50	30 - 40	0,20 - 0,30	6,3
	85 - 110 - 145	100 ÷ 220	30 - 45	0,10 - 0,20	0,25 - 0,75	30 - 40	0,20 - 0,35	6,3