

# Sets

Inserts

Face milling cutters

Square shoulder cutters

Slot cutters

Porcupine cutters

Specific applications and Sets

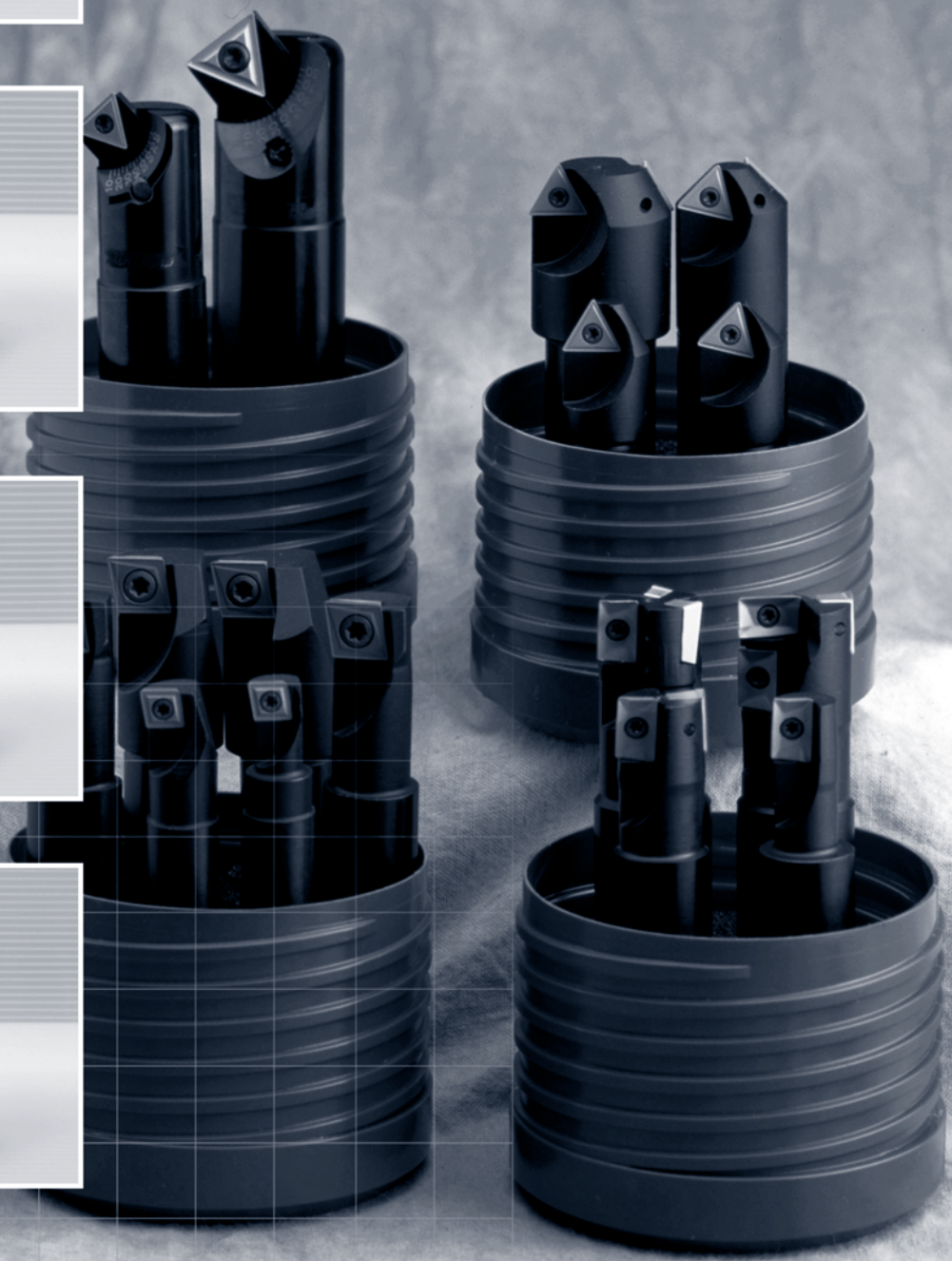

# Specific applications and Sets

## Specific applications

<b>02 34.00</b> Spot facing milling cutters  Page F.02 CC.. 0602.. CC.. 09T3..	<b>0624.21</b> Chamfering cutters  Page F.04 TC.. 1102..	<b>0724.21</b> Chamfering cutters  Page F.04 TC.. 1102..	<b>1220.21</b> Face and square 90°  Page F.06 AP.. 1003..	<b>2220.21</b> Face and square 90°  Page F.06 AP.. 1003..	<b>1135.01</b> Convexe milling cutters  Page F.08 ADMW-C 1503..
<b>1235.01</b> Concave milling cutters  Page F.10 ADMW-R 1503..	<b>1235.07</b> Concave milling cutters  Page F.10 ADMW-R 1503..	<b>16 2/4.21</b> Chamfering cutters  Page F.12 TC.. 1102.. TC.. 16T3..	<b>1725. 2/7</b> Chamfering cutters  Page F.14 ADMW-R 1503..	<b>1735. 2/7</b> Chamfering cutters  Page F.15 ADMW-C 1503..	<b>1744. 2/7</b> Chamfering cutters  Page F.16 SC.. 1204..
<b>3314.0 1/2</b> Multi-function  Page F.18 CCKT 0602.. CCKT 1204..	<b>9614.61</b> Back draft spot facing  Page F.20 CC.. 0602.. CC.. 09T3..	<b>9624.61</b> Back draft countersink  Page F.21 CC.. 0602.. TC.. 1102..			

## Sets

<b>SET MAXICUT</b> Spot facing milling cutters  Page F.03 CC.. 0602.. CC.. 09T3..	<b>SET MINICUT</b> Chamfering cutters  Page F.05 TC.. 1102..	<b>SET 1220</b> Face and square 90°  Page F.07 AP.. 1003..	<b>SET 1135</b> Convexe milling cutters  Page F.09 ADMW-C 1503..	<b>SET 1235</b> Concave milling cutters  Page F.11 ADMW-R 1503..	<b>SET MULTICUT</b> Chamfering cutters  Page F.13 TC.. 1102.. TC.. 16T3..
<b>SET CCKT</b> Multi-function  Page F.19 CCKT 0602.. CCKT 1204..					

# Specific applications and sets

For more information see page:

Contents: F.02  
Sets: F.03  
Tools: F.10

Inserts

Face milling cutters

Square shoulder cutters

Slot cutters

Porcupine cutters

Specific applications and Sets



### Characteristics:

Spot facing milling cutters for flat screw heads.

The inserts are fixed by Torx screw that allow a good chip evacuation and easy use.

### Applications:

Flat countersink.

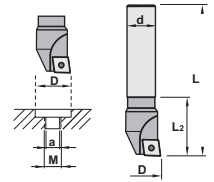
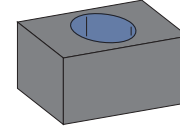
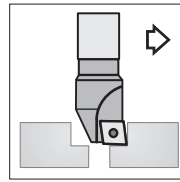

## 02<sup>1</sup><sub>3</sub>4.00

Ref.			D	d	a	L	L2	M	Insert size	
0214.00.011	1		11	12	4	85	15	M6	CC.. 0602..	0,100
0214.00.014	1		14	12	5	85	19	M8	CC.. 0602..	0,100
0234.00.017	1		17	16	5	95	30	M10	CC.. 09T3..	0,125
0234.00.019	1		19	16	5	95	32	M12	CC.. 09T3..	0,125
0234.00.022	1		22	16	6	95	32	M14	CC.. 09T3..	0,150
0234.00.025	1		25	16	8	95	32	M16	CC.. 09T3..	0,150

Ref.		
0214.00.011	1425	5507
0214.00.014	1425	5507
0234.00.017	1440	5515
0234.00.019	1440	5515
0234.00.022	1440	5515
0234.00.025	1440	5515

Ref.	CC..	l	s	d	Positive 7° clearance - 80° rhombic inserts.
	CC.. 0602..	6,45	2,38	6,35	
CC.. 09T3..	9,65	3,97	9,52		

CCGT-AL	CCKT	CCMW			

For more information see page: A.12



**Characteristics:**

Spot facing milling cutters for flat screw heads.

The inserts are fixed by Torx screw that allow a good chip evacuation and easy use.

**Applications:**

Flat countersink.

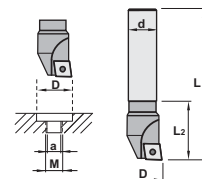
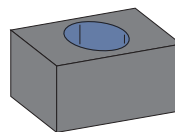
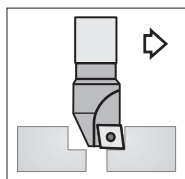

SET MAXICUT										
Ref.			D	d	a	L	L2	M	Insert size	
0214.00.011	1		11	12	4	85	15	M6	CC.. 0602..	0,800
0214.00.014	1		14	12	5	85	19	M8	CC.. 0602..	
0234.00.017	1		17	16	5	95	30	M10	CC.. 09T3..	
0234.00.019	1		19	16	5	95	32	M12	CC.. 09T3..	
0234.00.022	1		22	16	6	95	32	M14	CC.. 09T3..	
0234.00.025	1		25	16	8	95	32	M16	CC.. 09T3..	

Ref.		
0214.00.011	1425	5507
0214.00.014	1425	5507
0234.00.017	1440	5515
0234.00.019	1440	5515
0234.00.022	1440	5515
0234.00.025	1440	5515

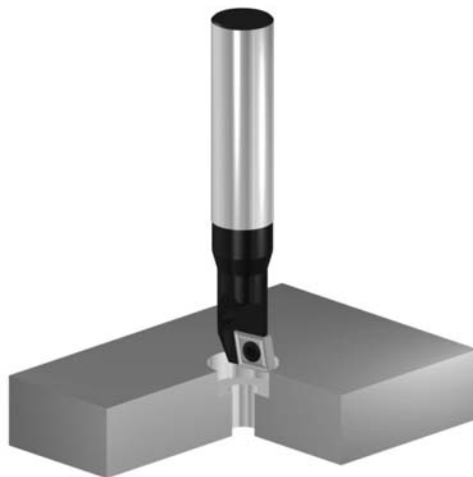

 	CC..				Positive 7° clearance - 80° rhombic inserts.
	Ref.	l	s	d	
	CC.. 0602..	6,45	2,38	6,35	
CC.. 09T3..	9,65	3,97	9,52		
	CCGT-AL	CCKT	CCMW		

For more information see page: A.12

Inserts

Face milling cutters

Square shoulder cutters

Slot cutters

Porcupine cutters

Specific applications and Sets



**Characteristics:**

Countersink milling cutter for specific operations. The insert is fixed by Torx screw that allow a good chip evacuation and an easy use.

**Applications:**

This chamfering milling cutters work well on steels, alloyed steels, stainless steels and refractors. This general milling cutter for diversified manufacture is recommended for small conventional milling machines and machining centers.

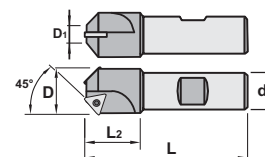
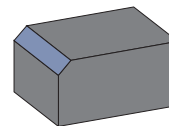
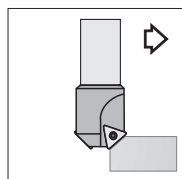

0624.21			D1	D	L	L2	d	Insert size	
Ref.	0624.21.016	1	1,2	16	70	24	12	TC.. 1102..	0,100
	0624.21.021	2	8,5	21	90	30	20	TC.. 1102..	0,150

Ref.	0624.21.016		1425		5507
	0624.21.021		1425		5507

**Characteristics:**

Countersink milling cutter for specific operations. The insert is fixed by Torx screw that allow a good chip evacuation and an easy use.

**Applications:**

This chamfering milling cutters work well on steels, alloyed steels, stainless steels and refractors. This general milling cutter for diversified manufacture is recommended for small conventional milling machines and machining centers.

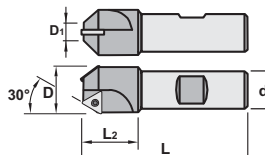
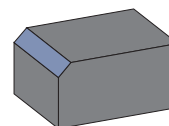
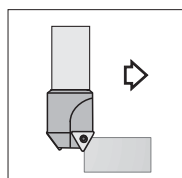

0724.21			D1	D	L	L2	d	Insert size	
Ref.	0724.21.016	1	5,4	16	70	24	12	TC.. 1102..	0,100
	0724.21.026	2	15,8	26	90	30	20	TC.. 1102..	0,170

Ref.	0724.21.016		1425		5507
	0724.21.026		1425		5507

	TC..				Positive 7° clearance - Triangular inserts.	
	Ref.	TC.. 1102..	l	s		d
			11,00	2,38		6,35
	TCGT-AL	TCMT-39	TCMW			

For more information see page: A.20





**Characteristics:**

Countersink milling cutter for specific operations. The insert is fixed by Torx screw that allow a good chip evacuation and an easy use.

**Applications:**

This chamfering milling cutters work well on steels, alloyed steels, stainless steels and refractors. This general milling cutter for diversified manufacture is recommended for small conventional milling machines and machining centers.

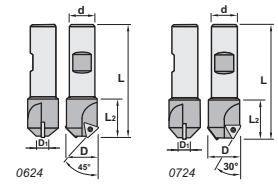
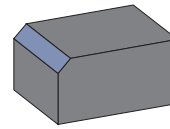
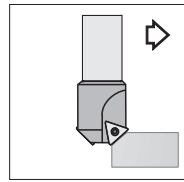

## SET MINICUT

Ref.			D1	D	L	L2	d	Insert size	
0624.21.016	1		1,2	16	70	24	12	TC.. 1102..	0,600
0624.21.021	2		8,5	21	90	30	20	TC.. 1102..	
0724.21.016	1		5,4	16	70	24	12	TC.. 1102..	
0724.21.026	2		15,8	26	90	30	20	TC.. 1102..	

Ref.		
0624.21.016	1425	5507
0624.21.021	1425	5507
0724.21.016	1425	5507
0724.21.026	1425	5507

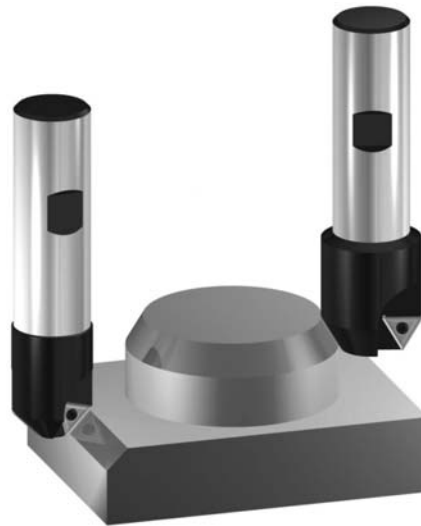

	TC..				Positive 7° clearance - Triangular inserts.
	Ref.	TC.. 1102..	l	s	
			11,00	2,38	6,35
	TCGT-AL	TCMT-39	TCMW		

For more information see page: A.20

Inserts

Face milling cutters

Square shoulder cutters

Slot cutters

Porcupine cutters

Specific applications and sets



**Characteristics:**

This positive milling cutter with an exact angle of 90° uses very strong inserts allowing deep passes and high feed per teeth. The insert is fixed by a Torx screw that allows a good chip evacuation and an easy use. Milling cutter equipped with short Weldon shank.

**Applications:**

This face and square (angle 90°), slot and side milling cutter works well on steels, alloyed steels, stainless steels, refractory casts and aluminium alloys. This general milling cutter for diversified manufacture is recommended for conventional milling machines and machining centers.

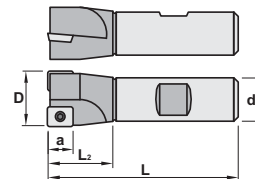
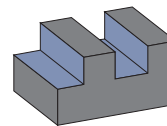
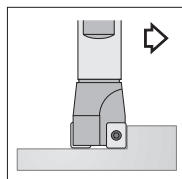

1220.21			D	d	a	L2	L	Insert size	
Ref.	1220.21.012	1	12	16	10	25	85	AP.. 1003..	0,100
	1220.21.016	2	16	16	10	25	85	AP.. 1003..	0,150
	1220.21.020	3	20	20	10	30	90	AP.. 1003..	0,150

Ref.	1220.21.012		1425	5507
	1220.21.016		1425	5507
	1220.21.020		1425	5507

**Characteristics:**

This super positive drill milling cutter with an exact angle of 90° uses strong inserts allowing deep passes. The insert is fixed by a Torx screw that allows a good chip evacuation and an easy use. Milling cutter equipped with short Weldon shank.

**Applications:**

This drill milling cutter, works well on steels, alloyed steels, stainless steels, refractory casts and aluminium alloys. This general milling cutter for diversified manufacture is recommended for conventional milling machines and machining centers.

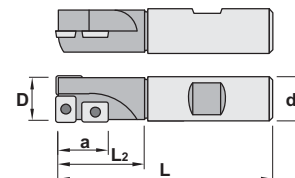
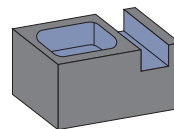
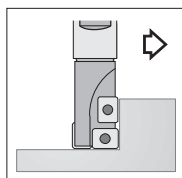

2220.21			D	d	a	L2	L	Insert size	
Ref.	2220.21.020	1+1	20	20	19	35	90	AP.. 1003..	0,150

Ref.	2220.21.020		1425	5507
------	-------------	--	------	------

AP..		l	s	d	Positive 11° clearance - Rectangular inserts.
Ref.	AP.. 1003..	9,52	3,18	6,35	
For more information see page: A.11					
APHT-AL	APKT				



**Characteristics:**

This positive milling cutter with an exact angle of 90° uses very strong inserts allowing deep passes and high feed per teeth. The insert is fixed by a Torx screw that allows a good chip evacuation and an easy use.

Milling cutter equipped with short Weldon shank.

**Applications:**

This face and square (angle 90°), slot and side milling cutter works well on steels, alloyed steels, stainless steels, refractory casts and aluminium alloys. This general milling cutter for diversified manufacture is recommended for conventional milling machines and machining centers.

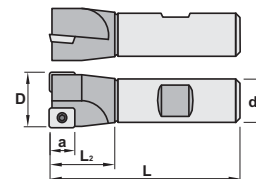
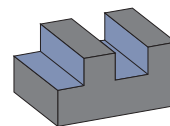
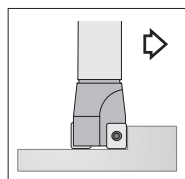

## SET 1220

Ref.			D	d	a	L2	L	Insert size	
1220.21.012	1		12	16	10	25	85	AP.. 1003..	0,650
	2		16	16	10	25	85	AP.. 1003..	
	3		20	20	10	30	90	AP.. 1003..	
	2220.21.020	1+1	20	20	19	35	90	AP.. 1003..	

Ref.		
1220.21.012	1425	5507
1220.21.016	1425	5507
1220.21.020	1425	5507
2220.21.020	1425	5507

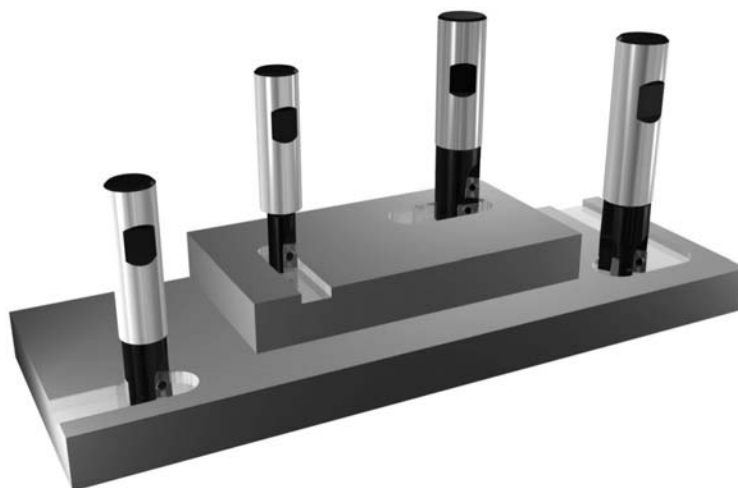

	AP..				Positive 11° clearance - Rectangular insert.
	Ref.	AP.. 1003..	l	s	
			9,52	3,18	6,35
	For more information see page: A.11				
	APHT-AL	APKT			

Specific applications and sets  
Profile milling  
Solid carbide  
Drills  
Boring heads  
Arbors and adaptors



Inserts

Face milling cutters

Square shoulder cutters

Slot cutters

Porcupine cutters

Specific applications and Sets



### Characteristics:

Convex milling cutters for specific applications.

The inserts are fixed by Torx screw that allow a good chip evacuation and easy use.

### Applications:

This chamfering milling cutters work well on steels, alloyed steels, stainless steels and refractors.

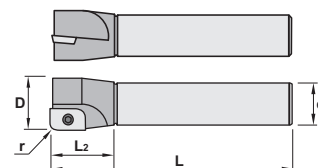
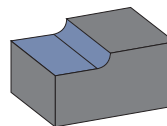
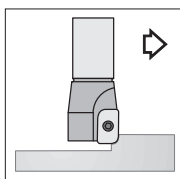

## 1135.01

Ref.			d	D	L	L2	r <sub>min</sub>	r <sub>max</sub>	Insert size	
1135.01.01610		1	16	16	120	35	1,0	3,0	ADMW-C 1503R1.0 / 3.0	0,200
1135.01.01635		1	16	16	120	35	3,5	6,0	ADMW-C 1503R3.5 / 6.0	0,200

Ref.		
1135.01.01610	1440	5515
1135.01.01635	1440	5515

Ref.	ADMW-C			Positive 15° clearance - Rectangular inserts.			
	r	s	d				
ADMW 1503R1.0-C	1.00	3,18	9,52				
ADMW 1503R1.5-C	1.50	3,18	9,52				
ADMW 1503R2.0-C	2.00	3,18	9,52				
ADMW 1503R2.5-C	2.50	3,18	9,52				
ADMW 1503R3.0-C	3.00	3,18	9,52				
ADMW 1503R3.5-C	3.50	3,18	9,52				
ADMW 1503R4.0-C	4.00	3,18	9,52				
ADMW 1503R4.5-C	4.50	3,18	9,52				
ADMW 1503R5.0-C	5.00	3,18	9,52				
ADMW 1503R6.0-C	6.00	3,18	9,52				
	R1.0-C	R1.5-C	R2.0-C	R2.5-C	R3.0-C	R3.5-C	R4.0-C

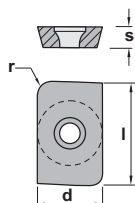

For more information see page: A.10



**Characteristics:**

Convex milling cutters for specific applications. The inserts are fixed by Torx screw that allow a good chip evacuation and easy use.

**Applications:**

This chamfering milling cutters work well on steels, alloyed steels, stainless steels and refractors.

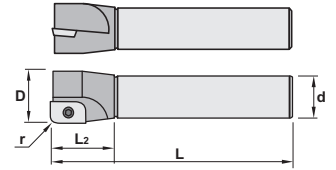
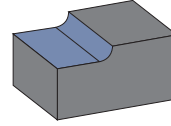
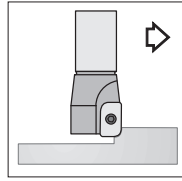

# SET 1135

Ref.			d	D	L	L2	r <sub>min</sub>	r <sub>max</sub>	Insert size	
1135.01.01610	1	16	16	120	35	1,0	3,0	ADMW-C 1503R1.0 / 3.0	0,550	
1135.01.01635	1	16	16	120	35	3,5	6,0	ADMW-C 1503R3.5 / 6.0		

Ref.			
1135.01.01610	1440		5515
1135.01.01635	1440		5515



Ref.	ADMW-C			Positive 15° clearance - Rectangular inserts.			
	r	s	d				
ADMW 1503R1.0-C	1.00	3,18	9,52				
ADMW 1503R1.5-C	1.50	3,18	9,52				
ADMW 1503R2.0-C	2.00	3,18	9,52				
ADMW 1503R2.5-C	2.50	3,18	9,52				
ADMW 1503R3.0-C	3.00	3,18	9,52				
ADMW 1503R3.5-C	3.50	3,18	9,52				
ADMW 1503R4.0-C	4.00	3,18	9,52				
ADMW 1503R4.5-C	4.50	3,18	9,52				
ADMW 1503R5.0-C	5.00	3,18	9,52				
ADMW 1503R6.0-C	6.00	3,18	9,52				
	R1.0-C	R1.5-C	R2.0-C	R2.5-C	R3.0-C	R3.5-C	R4.0-C

For more information see page: A.10

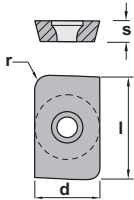

Inserts

Face milling cutters

Square shoulder cutters

Slot cutters

Porcupine cutters

Specific applications and Sets



**Characteristics:**

Concave milling cutters for specific applications. The inserts are fixed by Torx screw that allow a good chip evacuation and easy use.

**Applications:**

This chamfering milling cutters work well on steels, alloyed steels, stainless steels and refractors.

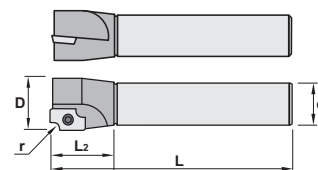
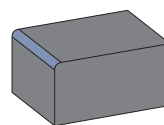
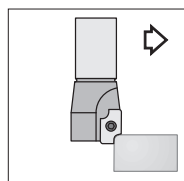

## 1235.01

Ref.	✳	d	D	L	L2	rmin	rmax	Insert size	Kg
1235.01.01701	1	16	17	120	30	1,0	2,5	ADMW 1503R1.0 / 2.5	0,200
1235.01.01703	1	16	17	120	30	3,0	5,0	ADMW 1503R3.0 / 5.0	0,200



Ref. 1235.01.01701	1440	5515
1235.01.01703	1440	5515

**Characteristics:**

Concave milling cutters for specific applications. The inserts are fixed by Torx screw that allow a good chip evacuation and easy use.

**Applications:**

This chamfering milling cutters work well on steels, alloyed steels, stainless steels and refractors.

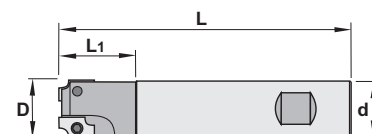
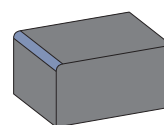
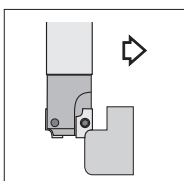

## 1235.07

Ref.	✳	D	d	L	L1	rmin	rmax	Insert size	Kg
1235.07.02201	2	22	20	120	35	1,0	2,5	ADMW 1503R1.0 / 2.5	0,320
1235.07.02203	2	22	20	120	35	3,0	5,0	ADMW 1503R3.0 / 5.0	0,530



Ref. 1235.07.02201	1440	5515
1235.07.02203	1440	5515

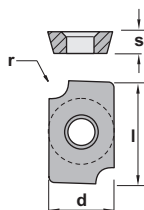

### ADMW-R

Ref.	r	s	d
ADMW 1503R1.0	1.0	3,18	9,52
ADMW 1503R1.5	1.5	3,18	9,52
ADMW 1503R2.0	2.0	3,18	9,52
ADMW 1503R2.5	2.5	3,18	9,52
ADMW 1503R3.0	3.0	3,18	9,52
ADMW 1503R3.5	3.5	3,18	9,52
ADMW 1503R4.0	4.0	3,18	9,52
ADMW 1503R4.5	4.5	3,18	9,52
ADMW 1503R5.0	5.0	3,18	9,52

Positive 15° clearance - Rectangular inserts

For more information see page: A.10

R1.0-R	R1.5-R	R2.0-R	R2.5-R	R3.0-R	R3.5-R	R4.0-R



**Characteristics:**

Concave milling cutters for specific applications.

The inserts are fixed by Torx screw that allow a good chip evacuation and easy use.

**Applications:**

This chamfering milling cutters work well on steels, alloyed steels, stainless steels and refractors.

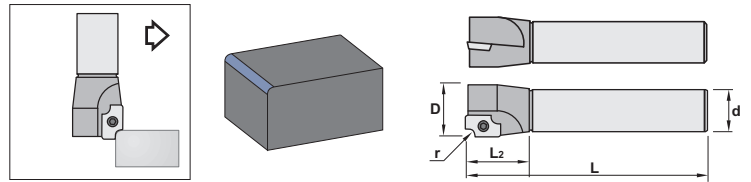

# SET 1235

Ref.			d	D	L	L2	r <sub>min</sub>	r <sub>max</sub>	Insert size	
1235.01.01701		1	16	17	120	30	1,0	2,5	ADMW 1503R1.0 / 2.5	0,550
1235.01.01703		1	16	17	120	30	3,0	5,0	ADMW 1503R3.0 / 5.0	

Ref.				
1235.01.01701			1440	5515
1235.01.01703			1440	5515



Ref.	ADMW-R				Positive 15° clearance - Rectangular inserts						
	r	s	d								
ADMW 1503R1.0	1.0	3,18	9,52								
ADMW 1503R1.5	1.5	3,18	9,52								
ADMW 1503R2.0	2.0	3,18	9,52								
ADMW 1503R2.5	2.5	3,18	9,52								
ADMW 1503R3.0	3.0	3,18	9,52								
ADMW 1503R3.5	3.5	3,18	9,52								
ADMW 1503R4.0	4.0	3,18	9,52								
ADMW 1503R4.5	4.5	3,18	9,52								
ADMW 1503R5.0	5.0	3,18	9,52								

For more information see page: A.10						
R4.5-R			R5.0-R			
R1.0-R	R1.5-R	R2.0-R	R2.5-R	R3.0-R	R3.5-R	R4.0-R

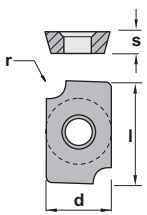

Specific applications and sets

Profile milling

Solid carbide

Drills

Boring heads

Arbors and adaptors

Inserts

Face milling cutters

Square shoulder cutters

Slot cutters

Porcupine cutters

Specific applications and Sets



### Characteristics:

Regulable chamfering milling cutter for specific operations. The insert is fixed by Torx screw that allow a good chip evacuation and an easy use.

### Applications:

This chamfering milling cutter for diversified manufacture is recommended for small conventional milling machines and machining centers.

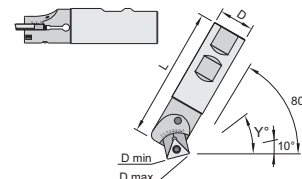
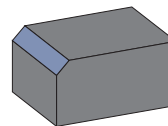
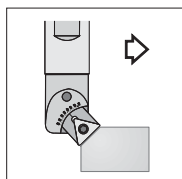

16 <sup>2</sup> <sub>3</sub> 4.2 <sup>1</sup> <sub>7</sub>			D	L	Y	Dmin	Dmax	Insert size	
Ref.	1624.21.020	1	20	100	10° - 80°	5	20	TC.. 1102..	0,250
	1634.21.025	1	25	100	10° - 80°	5	23	TC.. 16T3..	0,250
	1634.27.025	1	25	175	10° - 80°	5	23	TC.. 16T3..	0,500

Ref.	1624.21.020		6921		1225		1095		5507
	1634.21.025		6926		1240		1296		5515
	1634.27.025		6926		1240		1296		5515

Ref.	TC..	l	s	d	Positive 7° clearance - Triangular inserts.
	TC.. 1102..	11,00	2,38	6,35	
TC.. 16T3..	16,50	3,97	9,52		

TCGT-AL	TCMT-39	TCMW			

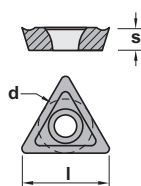

For more information see page: A.20



**Characteristics:**

Regulable chamfering milling cutter for specific operations. The insert is fixed by Torx screw that allow a good chip evacuation and an easy use.

**Applications:**

This chamfering milling cutter for diversified manufacture is recommended for small conventional milling machines and machining centers.

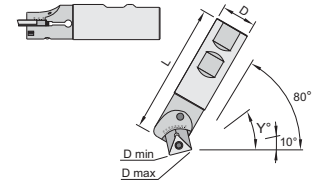
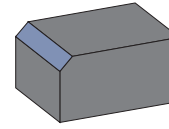
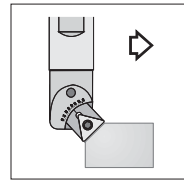

# SET MULTICUT

Ref.			D	L	Y	Dmin	Dmax	Insert size	
1624.21.020	1	20	100	10°	5	26	TC.. 1102..	0,600	
				20°	8	27			
				30°	10	27			
				40°	13	27			
				45°	14	27			
				50°	15	27			
				60°	17	26			
				70°	19	25			
				80°	20	24			
1634.21.025	1	25	100	10°	5	32	TC.. 16T3..	0,600	
				20°	6	33			
				30°	7	34			
				40°	10	33			
				45°	11	33			
				50°	13	32			
				60°	16	31			
				70°	19	29			
				80°	23	27			

Ref.				
1624.21.020	6921	1225	1095	5507
1634.21.025	6926	1240	1296	5515

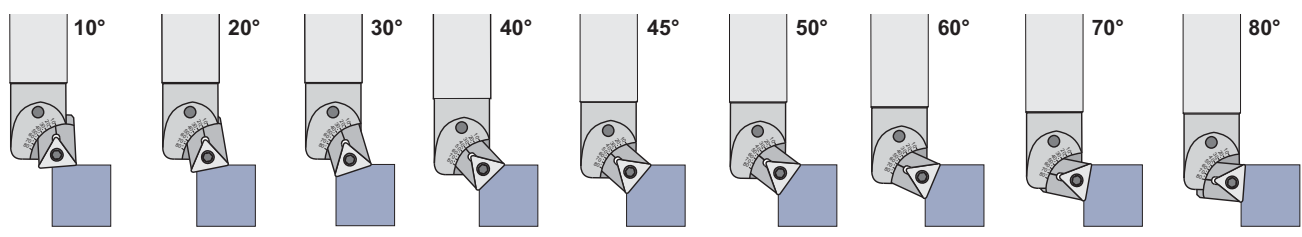

	TC..				Positive 7° clearance - Triangular inserts.
	Ref.	l	s	d	
	TC.. 1102..	11,00	2,38	6,35	
TC.. 16T3..	16,50	3,97	9,52		
For more information see page: A.20					
TCGT-AL	TCMT-39	TCMW			



Inserts

Face milling cutters

Square shoulder cutters

Slot cutters

Porcupine cutters

Specific applications and Sets



### Characteristics:

Regulable concave milling cutters for specific applications.

The inserts are fixed by Torx screw that allow a good chip evacuation and an easy use.

### Applications:

This chamfering milling cutters work well on steels, alloyed steels, stainless steels and refractors.

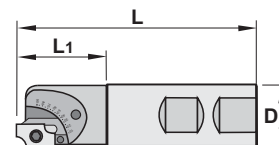
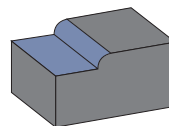
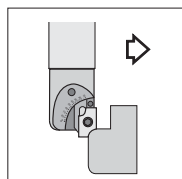

## 1725.07

Ref.			D	L	L1	Dmin	Dmax	Insert size	
1725.07.025		1	25,5	104	37	26,5	33,0	ADMW-R 1503	0,250
1725.27.025		1	25,5	178	37	26,5	33,0	ADMW-R 1503	0,500

Ref.					
1725.07.025		6925		1240	1296
1725.27.025		6925		1240	1296

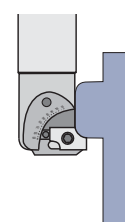
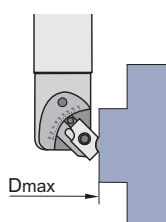
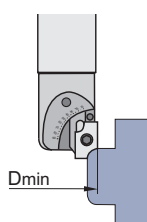

ADMW-R		r	s	d	Positive 11° clearance - Rectangular inserts.				
Ref.	ADMW 1503R1.0	1.0	3,18	9,52	For more information see page: A.10				
	ADMW 1503R1.5	1.5	3,18	9,52					
	ADMW 1503R2.0	2.0	3,18	9,52					
	ADMW 1503R2.5	2.5	3,18	9,52					
	ADMW 1503R3.0	3.0	3,18	9,52					
	ADMW 1503R3.5	3.5	3,18	9,52					
	ADMW 1503R4.0	4.0	3,18	9,52					
	ADMW 1503R4.5	4.5	3,18	9,52					
	ADMW 1503R5.0	5.0	3,18	9,52					
	R1.0	R1.5	R2.0	R2.5	R3.0	R3.5	R4.0	R4.5	R5.0



**Characteristics:**

Regulable convex milling cutters for specific applications. The inserts are fixed by Torx screw that allow a good chip evacuation and an easy use.

**Applications:**

This chamfering milling cutters work well on steels, alloyed steels, stainless steels and refractors.

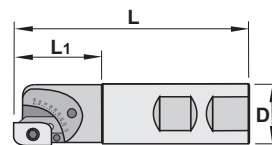
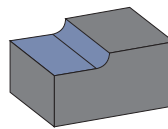
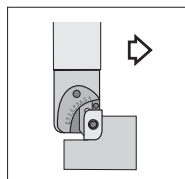

**1735.0<sup>0</sup>/<sub>2</sub>7**

Ref.			D	L	L1	Dmin	Dmax	Insert size	
1735.07.025		1	25,5	104	37	26,5	34,0	ADMW-C 1503	0,360
1735.27.025		1	25,5	178	37	26,5	34,0	ADMW-C 1503	0,650

Ref.					
1735.07.025	6935	1240	1296	1296	5515
1735.27.025	6935	1240	1296	1296	5515

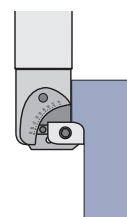
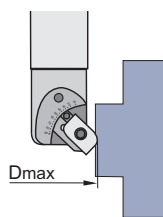
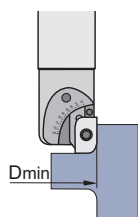

		ADMW-C			Positive 15° clearance - Rectangular inserts.		
Ref.		r	s	d			
	ADMW 1503R1.0-C	1.00	3,18	9,52			
	ADMW 1503R1.5-C	1.50	3,18	9,52			
	ADMW 1503R2.0-C	2.00	3,18	9,52			
	ADMW 1503R2.5-C	2.50	3,18	9,52			
	ADMW 1503R3.0-C	3.00	3,18	9,52			
	ADMW 1503R3.5-C	3.50	3,18	9,52			
	ADMW 1503R4.0-C	4.00	3,18	9,52			
	ADMW 1503R4.5-C	4.50	3,18	9,52			
	ADMW 1503R5.0-C	5.00	3,18	9,52			
	ADMW 1503R6.0-C	6.00	3,18	9,52			
					<b>R4.5-C</b>	<b>R5.0-C</b>	<b>R6.0-C</b>
	<b>R1.0-C</b>	<b>R1.5-C</b>	<b>R2.0-C</b>	<b>R2.5-C</b>	<b>R3.0-C</b>	<b>R3.5-C</b>	<b>R4.0-C</b>

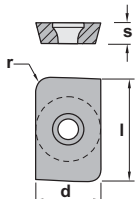

For more information see page: A.10

Inserts

Face milling cutters

Square shoulder cutters

Slot cutters

Porcupine cutters

Specific applications and Sets



**Characteristics:**

Regulable chamfering milling cutter for specific operations.

The insert is fixed by Torx screw that allow a good chip evacuation and an easy use.

**Applications:**

This chamfering milling cutter for diversified manufacture is recommended for small conventional milling machines and machining centers.

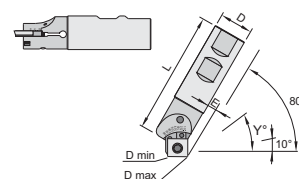
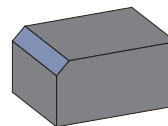
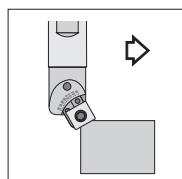

1744.07			D	L	Y	Dmin	Dmax	Insert size	
Ref.	1744.07.025	1	29	101	10°	7,5	30,0	SC.. 1204..	0,250
	1744.27.025	1	29	176	20°	10,0	32,0	SC.. 1204..	0,500
					30°	13,0	32,5		
					40°	16,5	33,5		
					45°	17,5	33,5		
					50°	19,0	33,5		
					60°	22,0	33,5		
					70°	24,5	32,5		
					80°	27,0	31,0		

Ref.				
1744.07.025	6944	1244	1296	5520
1744.27.025	6944	1244	1296	5520

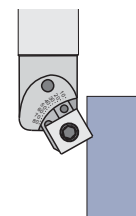
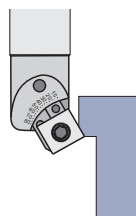
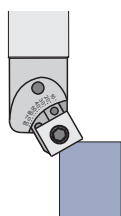

	SC..				Positive 7° clearance - Square inserts.
	Ref.	SC.. 1204..	l	s	
			12,70	4,76	12,70
	SCGT-AL	SCMT-39	SCMW		

For more information see page: A.16



Specific applications and sets

Profile milling

Solid carbide

Drills

Boring heads

Arbors and adaptors

Inserts

Face milling cutters

Square shoulder cutters

Slot cutters

Porcupine cutters

Specific applications and Sets



**Characteristics:** Multi-function center-cutting end mills.

**Applications:** Multiple applications - Side milling, drilling and face milling. Less time in tool changing on both-conventional and N/C machines. Easily able to machine in roughing and finishing applications because of the high rake geometry and high helix which reduce cutting forces for a smoother cut. Longer tool life may be expected because of the low cutting forces generated. Improved performance will be seen in comparison to conventional end mills and mill-drills, especially when ramp milling, drilling, contouring, helical interpolation of bores, pockets or normal profiling.

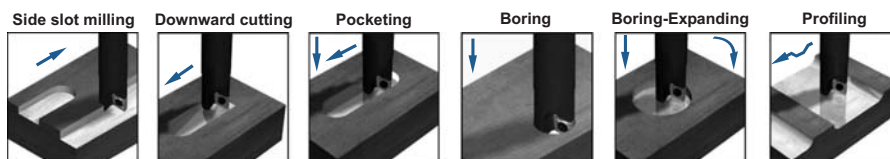
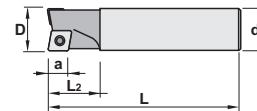

## 3314.0<sub>1</sub><sup>0</sup>

Ref.			D	d	L	L2	a	Insert size	
3314.00.012	1		12	16	100	25	5,0	CCKT 060204	0,120
3314.00.016	2		16	16	100	25	5,0	CCKT 060204 / 080308	0,160
3314.00.020	2		20	20	125	32	7,0	CCKT 080308 / 09T308	0,300
3314.00.025	2		25	25	125	40	7,6	CCKT 09T308 / 120408	0,480
3314.01.012	1		12	16	150	25	5,0	CCKT 060204	0,210
3314.01.016	2		16	16	175	25	5,0	CCKT 060204 / 080308	0,250
3314.01.020	2		20	20	175	32	7,0	CCKT 080308 / 09T308	0,400
3314.01.025	2		25	25	200	40	7,6	CCKT 09T308 / 120408	0,700

Ref.				
3314.00.012	1425	-	5507	-
3314.00.016	1425	1430	5507	5508
3314.00.020	1430	1440	5508	5515
3314.00.025	1440	1245	5515	-
3314.01.012	1425	-	5507	-
3314.01.016	1425	1430	5507	5508
3314.01.020	1430	1440	5508	5515
3314.01.025	1440	1245	5515	-

		<b>CCKT</b>			Positive 7° clearance - 80° rhombic inserts.  For more information see page: A.12
Ref.	CCKT	l	s	d	
	CCKT 0602..	6,45	2,38	6,35	
	CCKT 0803..	8,05	3,18	7,94	
	CCKT 09T3..	9,65	4,00	9,52	
	CCKT 1204..	12,90	4,76	12,70	





**Characteristics:** Multi-function center-cutting end mills.  
**Applications:** Multiple applications - Side milling, drilling and face milling. Less time in tool changing on both-conventional and N/C machines. Easily able to machine in roughing and finishing applications because of the high rake geometry and high helix which reduce cutting forces for a smoother cut. Longer tool life may be expected because of the low cutting forces generated. Improved performance will be seen in comparison to conventional end mills and mill-drills, especially when ramp milling, drilling, contouring, helical interpolation of bores, pockets or normal profiling.

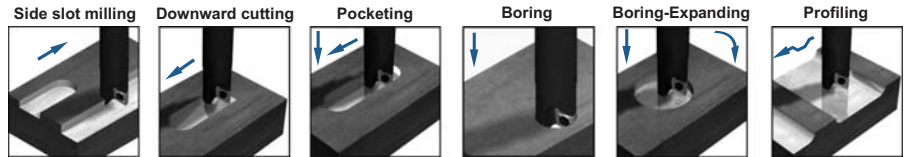
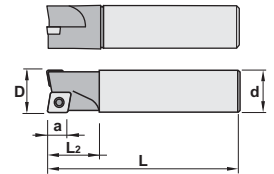

CCKT			D	d	L	L2	a	Insert size	
Ref.	3314.00.012	1	12	16	100	25	5,0	CCKT 060204	1,350
	3314.00.016	2	16	16	100	25	5,0	CCKT 060204 / 080308	
	3314.00.020	2	20	20	125	32	7,0	CCKT 080308 / 09T308	
	3314.00.025	2	25	25	125	40	7,6	CCKT 09T308 / 120408	
	3314.01.012	1	12	16	150	25	5,0	CCKT 060204	
	3314.01.016	2	16	16	175	25	5,0	CCKT 060204 / 080308	
	3314.01.020	2	20	20	175	32	7,0	CCKT 080308 / 09T308	
	3314.01.025	2	25	25	200	40	7,6	CCKT 09T308 / 120408	

Ref.				
3314.00.012	1425	-	5507	-
3314.00.016	1425	1430	5507	5508
3314.00.020	1430	1440	5508	5515
3314.00.025	1440	1245	5515	-
3314.01.012	1425	-	5507	-
3314.01.016	1425	1430	5507	5508
3314.01.020	1430	1440	5508	5515
3314.01.025	1440	1245	5515	-

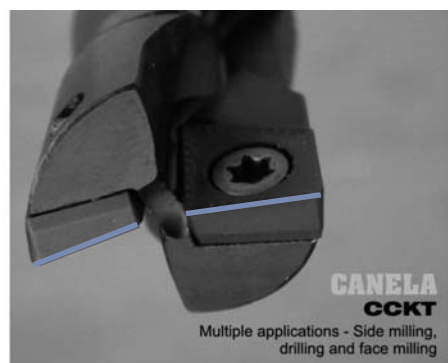

CCKT		l	s	d	Positive 7° clearance - 80° rhombic inserts.
Ref.	CCKT 0602..	6,45	2,38	6,35	
	CCKT 0803..	8,05	3,18	7,94	
	CCKT 09T3..	9,65	4,00	9,52	
	CCKT 1204..	12,90	4,76	12,70	

CCKT					

For more information see page: A.12



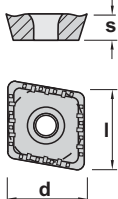

Inserts

Face milling cutters

Square shoulder cutters

Slot cutters

Porcupine cutters

Specific applications and Sets



### Characteristics:

Back draft spot facing milling cutters for flat screw heads.  
The inserts are fixed by Torx screw that allow a good chip evacuation and easy use.

### Applications:

Flat countersink.

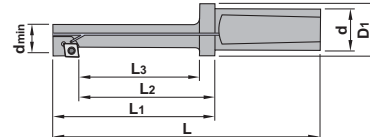
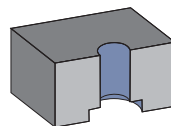
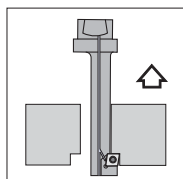

## 9614.61



Spot facing mills with internal coolant.

Ref.			D	dmin	d	L	L1	L2	L3	D1	Insert size	
9614.61.018	1	18	10,5	20	112	62	47	40	25	CC.. 0602..	0,280	
9614.61.020	1	20	13,0	20	113	63	52	45	25	CC.. 0602..	0,300	
9614.61.024	1	24	15,0	20	118	68	57	50	25	CC.. 0602..	0,320	
9614.61.026	1	26	17,0	20	128	78	67	60	25	CC.. 0602..	0,380	
9614.61.030	1	30	19,0	20	138	88	77	70	25	CC.. 0602..	0,400	
9614.61.033	1	33	21,0	20	152	102	82	75	25	CC.. 09T3..	0,430	

Ref.		
9614.61.018	1425	5507
9614.61.020	1425	5507
9614.61.024	1425	5507
9614.61.026	1225	5507
9614.61.030	1225	5507
9614.61.033	1440	5515

Ref.	CC..	l	s	d	Positive 7° clearance - 80° rhombic inserts.
CC.. 0602..		6,45	2,38	6,35	
CC.. 09T3..		9,65	3,97	9,52	
	CCGT-AL	CCKT	CCMW		

For more information see page: A.12



**Characteristics:**

Back draft countersink milling cutter for specific operations. The insert is fixed by Torx screw that allow a good chip evacuation and an easy use.

**Applications:**

This chamfering milling cutters work well on steels, alloyed steels, stainless steels and refractors. This general milling cutter for diversified manufacture is recommended for small conventional milling machines and machining centers.

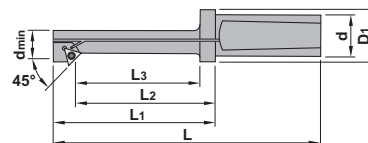
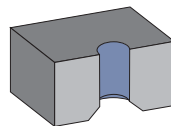
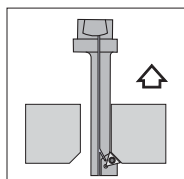

**9624.61**



Chamfering mills with internal coolant.

Ref.			D	d <sub>min</sub>	d	L	L <sub>1</sub>	L <sub>2</sub>	L <sub>3</sub>	D <sub>1</sub>	Insert size	
9624.61.015	1		15	10	20	105	55	42	35	25	CC.. 0602..	0,280
9624.61.020	1		20	14	20	110	60	47	40	25	CC.. 0602..	0,300
9624.61.023	1		23	17	20	120	70	57	50	25	TC.. 1102..	0,320
9624.61.027	1		27	21	20	140	90	77	70	25	TC.. 1102..	0,380
9624.61.031	1		31	24	20	150	100	87	80	25	TC.. 1102..	0,400

Ref.				
9624.61.015			1425	5507
9624.61.020			1425	5507
9624.61.023			1225	5507
9624.61.027			1225	5507
9624.61.031			1225	5507

Ref.	CC.. / TC..		l	s	d	CC.. Positive 7° clearance - 80° rhombic inserts. For more information see page: A.12
	CC.. 0602..		6,45	2,38	6,35	
TC.. 1102..		11,00	2,38	6,35		
CCGT-AL	CCKT	CCMW	TCGT-AL	TCMT-39	TCMW	

Specific applications and sets

Profile milling

Solid carbide

Drills

Boring heads

Arbors and adaptors