



CORTAVARILLAS

BOLT CUTTERS

COUPES-BOULONS

Los cortavarillas Ega Master están perfectamente diseñados y fabricados para cortar varillas cilíndricas, varillas de encofrador, mallas de alambre, cables, pernos, etc.

Ega Master bolt cutters are perfectly designed and manufactured for cutting rod, bolts, concrete from ties, cable and wires.

Les coupes-boulons Egamaster sont parfaitement conçus et fabriqués pour la coupe des tiges, des boulons, des câbles et des fils.

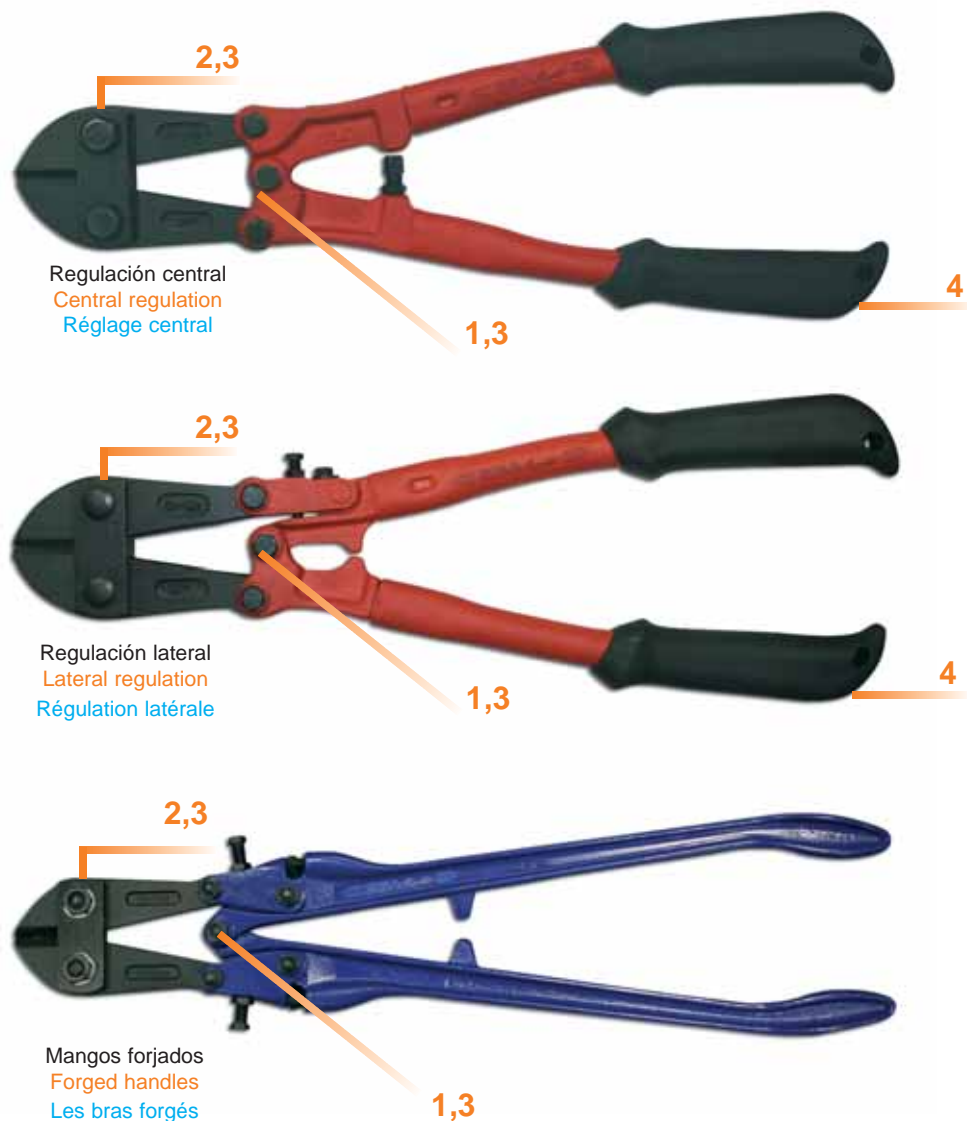

1 Sistema multiplicador de par de corte.
Cutting leverage multiplying system.
Accroissement de la coupe par le système multiplicateur.

3 Gran capacidad de corte
Great cutting capacity
Capacité de coupe très importante.

4 Mangos ergonómicos y confortables.
Ergonomic and comfortable handles.
Poignées ergonomiques et confortables.

2 El diseño especial reforzado de cabeza permite cortar varillas, pernos, etc. a muy poca distancia de la superficie desde la que sobresalen. El juego de cuchillas están fabricadas en cromo-molibdeno, dándole una mayor resistencia y durabilidad gracias a la dureza 62 HRC.

Its strong & specially designed head permits cutting bolts and rods at a very small distance from the surface where they stick out from. Cutting-blades are made in Chrome-Molibdenum, providing a bigger resistance and durability due to their 62 HRC hardness.

Les lames sont fortes et particulièrement conçues pour couper des boulons et sont tiges à une distance très petite de la surface. Les lames de coupe sont faites en Chrome-Molibdenum, fournissant une plus grande résistance et longévité due à leur dureté de 62 HRC.

CORTAVARILLAS / BOLT CUTTERS / COUPE-BOULONS / BOLZENSCHNEIDER / TAGLIABULLONI
BOUTENSCHAREN / CORTA VARÃO

A

COD ← L → ← A → ← B → ← C →

COD	L	A	B	C	55Kg/mm ² / 145Kg/mm ²	Kg.	
62193	14"	60	26	7	7-5	1,1	1
62194	18"	70	29	8	8-6	1,5	
62195	24"	85	33	9,6	10-8	2,4	
62196	30"	97	36	11,3	13-10	3,7	
62197	36"	109	39	13	16-12	5,8	
62198	42"	120	43	14	19-14	8,2	
62199	48"	155	60	17	22-16	14	

B

COD ← L → ← A → ← B → ← C →

COD	L	A	B	C	55Kg/mm ² / 145Kg/mm ²	Kg.	
62201	14"	60	26	7	7-5	1,1	1
62202	18"	70	29	8	8-6	1,5	
62203	24"	85	33	9,6	10-8	2,4	
62204	30"	97	36	11,3	13-10	3,7	
62205	36"	109	39	13	16-12	5,8	
62206	42"	120	43	14	19-14	8,2	

A	B	L
64096	64056	14"
64097	64057	18"
64098	64058	24"
64099	64059	30"
64100	64060	36"
64101	64061	42"

KIT 9 PCS. -COD. A-
PCS. **COD:62191**

2	62193	14"
2	62194	18"
2	62195	24"
2	62196	30"
1	62197	36"

KIT 9 PCS. -COD. B-
PCS. **COD:62190**

2	62201	14"
2	62202	18"
2	62203	24"
2	62204	30"
1	62205	36"



CORTAVARILLAS / BOLT CUTTERS / COUPE-BOULONS / BOLZENSCHNEIDER / TAGLIABULLONI
BOUTENSCHAREN / CORTA VARÃO

MANGOS FORJADOS / FORGED HANDLES / MANCHES FORGÉS / STAHL GESCHMIEDET / MANICI FORGIHTI / CABOS FORJADOS

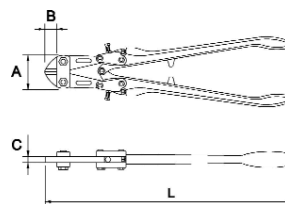

COD	L	A	B	C	CAP 55kg/mm² / 1450kg/mm²	Kg.	
62785	14"	61	26	7	7-5	1,3	1
62786	18"	71	32	8	8-6	1,8	
62787	24"	85	34	9,5	10-8	3,2	
62788	30"	96	39,5	11	13-10	4,7	
62789	36"	108	43	13	16-12	7	



64453	14"
64454	18"
64455	24"
64456	30"
64457	36"



KIT 9 PCS.

PCS.	COD:	62192
2	62785	14"
2	62786	18"
2	62787	24"
2	62788	30"
1	62789	36"

MANGOS FORJADOS / FORGED HANDLES / MANCHES FORGÉS / STAHL GESCHMIEDET / MANICI FORGIHTI / CABOS FORJADOS
BOCAS HSS / HSS BLADES / BECS HSS / SCHNELLSTAHL MESSER / LAMA HSS / HSS MESSEN / BOCAS HSS

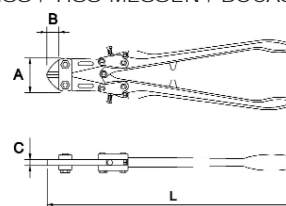

COD	L	A	B	C	HSS	CAP 55kg/mm² / 1450kg/mm²	Kg.	
62808	18"	71	32	8	HSS	8-6	1,8	1
62809	24"	85	34	9,5		10-8	3,2	
62810	30"	96	39,5	11		13-10	4,7	
62811	36"	108	43	13		16-12	7	



64453	HSS	18"
64454		24"
64455		30"
64456		36"



Capaz de cortar varilla hasta 500°C
Able to cut bolts up to 500°C
Coupe possible de barres jusqu'à 500C

MANGOS DE ALUMINIO / ALLUMINIUM HANDLES / MANCHES EN ALUMINIUM / ALU GRIFFE / MANICO IN ALLUMINIO / ALUMINIUM GREPEN / CABO DE ALUMÍNIO

NEW

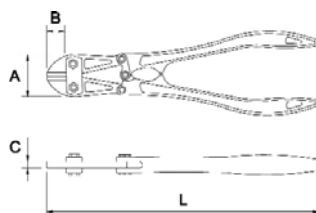

COD	L	A	B	C	CAP 25Kg/mm² 140Kg/mm²	Kg.	
62798	12"	51	20	6	3-5	0,78	
62799	14"	61	26	7	7-5	1,14	1
62800	18"	71	32	8	8-6	1,95	

	L
64667	12"
64453	14"
64454	18"

CORTAVARILLAS FILO ANGULAR / ANGULAR EDGE BOLT CUTTERS / COUPE BOULON TRANCHANT ANGULAIRE / ECKRAND BOLZENSCHNEIDER / TAGLIABULLONI FILO ANGOLARE / HOEKKANT BOUTENSCHAAR / CORTA VARAÃO DE FIO ANGULAR

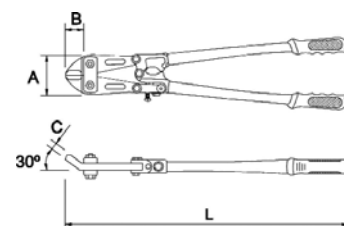

NEW

COD	L	A	B	C	CAP 25Kg/mm² 140Kg/mm²	Kg.	
62813	18"	70	29	8	8-6	1,8	1
62814	24"	85	33	9,6	10-8	2,6	

	L
64689	18"
64690	24"

CORTAVARILLAS / BOLT CUTTERS / COUPE-BOULONS / BOLZENSCHNEIDER / TAGLIABULLONI BOUTENSCHAREN / CORTA VARAÃO

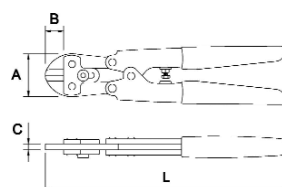

COD	L	A	B	C	CAP 140Kg/mm²	Kg.	
62200	8"	39	16	4,5	3	0,3	8

CORTAVARILLAS DE MESA / BOLT CUTTER BENCH TYPE / COUPE-BOULONS HORIZONTAL / TISCHBOLZENSCHNEIDER
TAGLIABULLONI DA BANCO / BANKBOUTENSCHAREN / CORTA VARÃO DE BANCADA

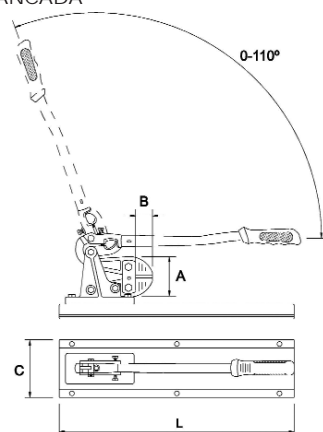

COD	L	A	B	C	CAP	Kg.	
62513	24"	85	34	137	50Kg/mm ² 145Kg/mm ²	5,7	1

64334	24"
-------	-----

CORTAVARILLAS BOCA PELICANO / PELICAN BOLT CUTTER / COUPE-BOULONS "BEC PELICAN" / PELIKAAN-BOLZENSCHNEIDER
PELIKAAN BOUTSNIJDER / TAGLIABULLONI / TESOURA CORTA VARAO BOCA PELICANO

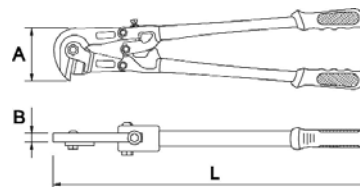

COD	L	A	B	CAP	Kg.	
62514	24"	101	9,5	9	2,77	1

64335	32"
-------	-----

CORTACABLES DE ACERO / WIRE ROPE CUTTER / COUPE CABLES / STAHLDRAHTSCHNEIDER / CESOIA PER CAVI
STAALDRAADSNIJDER / TESOURA CORTA CABOS DE AÇO

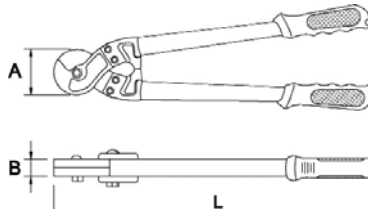

COD	L	A	B	CAP	Kg.	
62515	18"	67	8	12	1,68	1
62516	32"	89	9	16	3,65	

64331	18"
64332	32"

CORTACABLES DE ACERO REFORZADO / H.D. WIRE ROPE CUTTER / COUPE CABLES EN ACIER RENFORCE
STAHLDRAPHTSCHNEIDER, VERSTÄRKT / CESCOIA PER CAVI / H.D. STAALDRAADSNIJDER
TESOURA CORTA CABOS DE AÇO REFORÇADO



COD	L	A	B	CAP 55Kg/mm ² 140Kg/mm ²	Kg.	
62517	24"	91,4	9,5	14-10	2,4	1
62518	36"	103,4	13	18-12	4,7	
62519	42"	119,2	15	22-13	7,9	

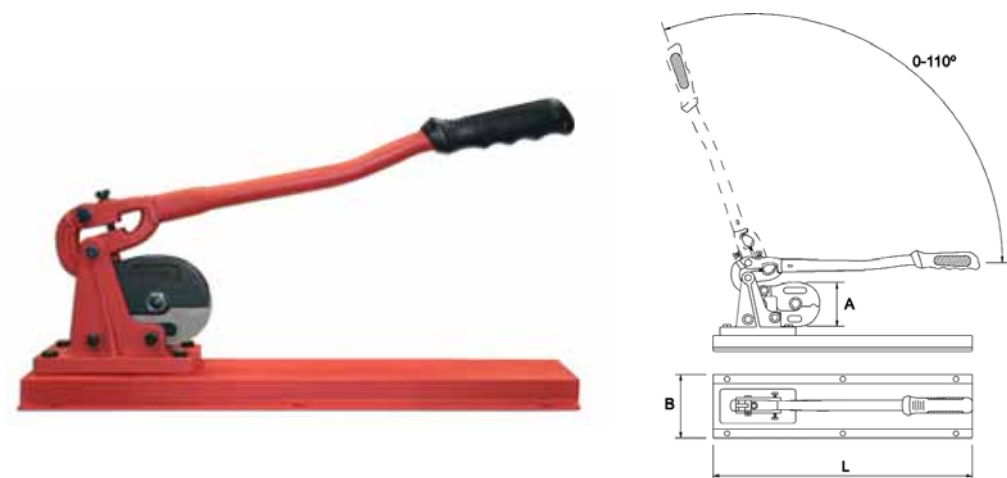

COD	L	A	B	CAP 55Kg/mm ² 140Kg/mm ²	Kg.	
62520	24"	91,4	137	10-8	5,5	1

	L
64328	24"
64329	36"
64330	42"

EGA Master S.A.
ART IN INNOVATION

TENAZA DE ENGASTAR / SWAGING TOOL / PINCE A SERTIR / KABELKLEMMZANGE / PINZA PER CAPICORDA / KABELKLEMTANG
TURQUES DE ENGASTAR



COD						
62521	24"	86	12	1,5-6mm	2,5	1

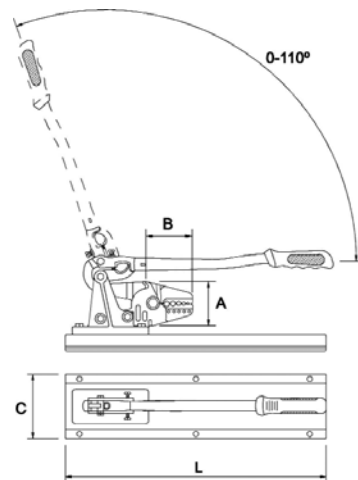

COD							
62522	24"	86	79	137	1,5-6mm	5,8	1

nº1	nº2	nº3	nº4	nº5
Ø1,5 (2,35mm ²) Ø2 (3,14mm ²)	Ø2,5 (4,90mm ²) Ø2,8 (6,15mm ²)	Ø3(7,06mm ²) Ø3,5 (9,62mm ²)	Ø4(12,56mm ²)	Ø5(19,63mm ²)

Para / for / pour:



64333	24"

La más galardonada
The most awarded
La plus primée

ARCO DE SIERRA / HACK SAW / MONTURE DE SCIE A METAUX / METALLSÄGEBOGEN ARCHETTI / ZAAGBOGEN / ARCOS DE SERRA

KRONOS

45° & 90°

COD			
63742	12"-300mm	905	6

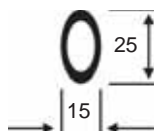

ALU

APOLO

45° & 90°

COD			
63749	12"-300mm	730	6

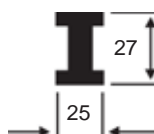

ALU

EFESTO

45° & 90°

COD			
63304	12"-300mm	770	6

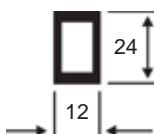

ALU

HERCULES

45° & 90°

COD			
63748	12"-300mm	590	6

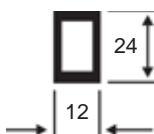

ALU

ULISES

45° & 90°

COD			
63747	12"-300mm	560	6

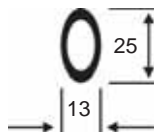

ALU + ABS

EOLO

45° & 90°

COD			
63746	12"-300mm	530	6

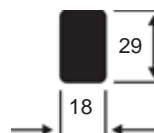

ABS

TITAN

90° & 180°

COD			
63745	12"-300mm	450	6

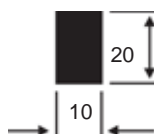

ACERO / STEEL / ACIER

MINIPROF 90°

COD	6"-150mm	260	6
63744			

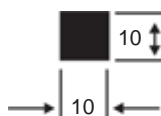

MINICUT 90° & 180°

COD	6"-150mm	255	6
63743			

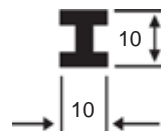

HOJAS DE SIERRA / HACK SAW BLADES / LAMES DE SCIÉS / METALLSÄGEBLÄTTER / LAME PER ARCHETTI / ZAAGBLADEN
FOLHA DE SERRA

ACERO AL CARBONO / CARBON STEEL / ACIER AU CARBONE

COD	L	TPI	Kg.
64433	12"	14	100
64434		18	
64435		24	
64436		32	



HSS-BIMETAL

COD	L	TPI	Kg.
64437	12"	14	100
64438		18	
64439		24	
64440		32	



IRROMPIBLE / UNBREAKABLE / INDÉCHIRABLÉ

HSS-BIMETAL (COBALT)

COD	L	TPI	Kg.
64441	12"	14	100
64442		18	
64443		24	
64444		32	



IRROMPIBLE / UNBREAKABLE / INDÉCHIRABLÉ

ACERO ESPECIAL TEMPLADO / HARDENED SPECIAL STEEL / ACIER TREMPÉ SPÉCIAL / GEHÄRTET SPEZIAL STAHL / ACCIAIO SPECIALE TEMPRATO / GEHARD SPECIAL STAAL / AÇO ESPECIAL TEMPERADO

COD	L	TPI	Blister
63771	6"	24	30



NEW

SIERRA PARA PVC/ABS / PVC/ABS CUTTING SAW / SCIE A PVC / PVC/ABS SÄGE / SEGHETTO PER PVC/ABS / PVC/ABS ZAGEN
SERRA PARA PLÁSTICO

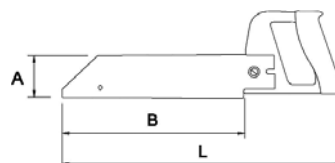

COD	L	A	B	TPI	Blister
63379	395	64mm	12" (300)	18	300
64458					
64459					

TIJERAS ARTICULADAS / AVIATION TIN SNIPS / CISAILLE ARTICULEE / BLECHSCHEREN MIT HEBELÜBERSETZUNG
CESOIE A DOPPIA LEVA / KNIPSCHAREN TESOURAS ARTICULADAS

DR

COD	mm	inch.	CAP	BT.		
62169	250	10"	1,2	380	6	1

Cr-V



COD	mm	inch.	CAP	BT.		
62170	250	10"	1,2	380	6	1

Cr-V



ILGL

COD	mm	inch.	CAP	BT.		
62171	250	10"	1,2	380	6	1

Cr-V



TIJERAS ARTICULADAS REFORZADAS / REINFORCED AVIATION TIN SNIPS / RENFORCEE CISAILLE ARTICULEE
BLECHSCHEREN MIT HEBELÜBERSETZUNG, VERSTÄRKT / CESOIE A DOPPIA LEVA RINFORZATA / VERSTERKET KNIPSCHAREN
TESOURAS ARTICULADAS REFORÇADAS

DR

COD	mm	inch.	CAP	BT.		
62188	250	10"	1,2	470	6	1

Cr-V



ILGL

COD	mm	inch.	CAP	BT.		
62189	250	10"	1,2	470	6	1

Cr-V



TIJERAS PARA CHAPA / TIN SNIPS / CISAILLES A TOLE / BLECHSCHEREN / CESOIE PER LAMIERA / HANDSCHAAR
TESOURA PARA CHAPA

COD	inch.	CAP	BT.		
62232	8"	0,5	350	6	1
62159	10"	1	540		
62233	12"	1,2	700		
62234	14"	1,2	900		



BRITISH TYPE

COD	L	CAP	GF.		
62267	8"	0,5	245	6	1
62268	10"	1	490		
62269	12"	1,2	680		
62270	14"		885		



CIZALLA ROEDORA / RATCHET SNIP / GRIGNOTEUSE / NIBBELSCHERE / CESCOIE RODITRICI / KNIPSCHAAR MET RATEL TESOURA ROEDORA

COD	L	CAP	GF.			
62160	10"	1,2	465	6	1	80075



CORTADORES / CUTTERS / CUTTERS / CUTTER / COLTELLI UNIVERSALI / MESSEN / X-ACTOS

COD					
69501	0,6	115	10	1	64005



COD					
69502	0,6	35	10	1	64005



COD					
69509	0,6	265	10	1	64005



CARGA AUTOMÁTICA CON 10 CUCHILLAS / AUTOMATIC LOAD WITH 10 BLADES / CHARGE AUTOMATIQUE AVEC 10 LAMES

CORTAFRIOS / COLD CHISEL / BURINS / FLIESENMEISSEL / SCALPELLI ATAGLIENTE DIRITTO / ESCOPRO

COD	HxL	GF.		
63178	15x160	150	6	1
63179	20x200	275		
63180	22x250	380		



SET

63761	63178	15x160 mm
	63179	20x200 mm
	63180	22x250 mm



CINCEL CHAPISTA / EXTRA FLAT COLD CHISEL / BURIN DE CARROSSIER / SCHLITZMEISSEL / SCALPELLO A FREDDO PIATTO EXTRA PLATTE KOUDBEITEL / ESCOPRO FINO

COD	L	A	GF.		
63472	204	27	245	6	1

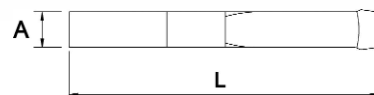

CINCEL / FLAT CHISEL / CISEAUX DE MAÇON / FLACHMEISSEL / SCALPELLI PER MURATORI / ESCOPRO

COD	L	A	B	gr.	
63309	200	23		300	
63310	250	24	16	390	
63311		24		485	
63315	300	25		580	
63316	350	26	18	700	6
63317		27		800	
63320	400	27		950	
63321	500	28	20	1200	

COD	L	A	B	gr.	
63326	200	23		450	
63327	250	24	16	540	
63328		24		635	
63332	300	25		730	
63333	350	26	18	850	6
63334		27		950	
63337	400	27		1100	
63338	500	28	20	1350	

PUNTERO / POINTED CHISEL / BROCHE / SPITZMEISSEL / SCALPELLI PER MURATORI / PONTEIRO

COD	L	A	gr.	
63339	200		300	
63340	250	16	390	
63341			485	
63342	300		580	
63343	350	18	700	6
63344			800	
63345	400		950	
63346	500	20	1200	

COD	L	A	gr.	
63347	200		450	
63348	250	16	540	
63349			635	
63350	300		730	
63351	350	18	850	6
63352			950	
63353	400		1100	
63354	500	20	1350	

CINCEL MECANICO / FLAT COLD CHISEL / BURIN MÉCANIQUE / FLACH MEIß EL / SCALPELLO PER MECCANICO / VLAkke BEITEL
ESCO PRO MECÁNICO

NEW



COD	L	A	B	C	gr.	
62847	100	11	7	12	65	6
62848	125	14	9	15	115	
62849	150	17	11	18	225	
62850	200	20	12	21	280	
62851	225			24	290	
62852	250			25	300	
62853	250	23	13	28	320	
62854	300			26	460	
62855	400			29	480	
62856	300	26	13	30	500	
62857	400			540		
62858	500			30	560	

NEW



COD	L	A	B	C	gr.	
62862	200	20	12	21	330	6
62863	225			24	340	
62864	250			25	350	
62865	250	23	13	28	370	
62866	300			26	510	
62867	300			29	530	
62868	400	26	13	30	550	
62869	400			590		
62870	500			30	610	

BURIL PLANO / CROSSCUT CHISEL / BÉDANE PLATE / KREUZSCHNITT MEIß EL / BULINO PIATTO / DWARSBEITEL / BURIL PLANO

NEW

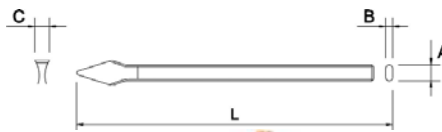

COD	L	A	B	C	gr.	
62871	125	14	9	5	90	6
62872	150	16	10	6	150	
62873	175	17	11	7	240	
62874	200	20	12	8	280	
62875	250	23	13	9	300	
62876	300			9	315	

NEW

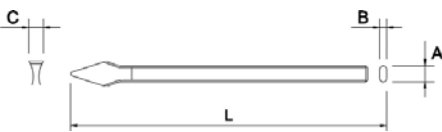

COD	L	A	B	C	gr.	
62880	200	20	12	8	330	6
62881	250	23	13	9	350	
62882	300			9	365	

CINCEL PARA LADRILLOS / BOLSTER CHISEL / CISEAUX A BRIQUES / FUGENMEISSEL / SCALPELLI DA PIASTRELLISTA
ESCOPRO PARA LADRILHOS

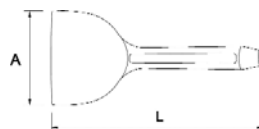

COD	L	A	gr.	
63181	220	60	355	6
63182	240	75	710	
63191		100	875	

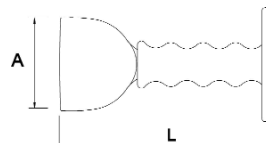

COD	L	A	gr.	
63183	220	60	415	6
63184	240	75	740	
63192		100	1040	

CINCELES, BOTADORES Y GRANETES / CHISELS AND PUNCHES / BURINS, CHASSE-GOUPILLES ET POINTEAUX / MEIß EL UND DURCHSCHLÄGE / SCALPELLI E PUNZONI / BEITELS EN DOORSLAGERS / ESCOPROS, SACA-TROÇOS E PUNÇÕES



NEW



NEW

COD	Composición / Composition	gr.
A- 69953	Cinzel mecánico / Cold chisel: 15x12x150 & 11x10x130mm Butil plano / Crosscut chisel: 5x10x150mm Granete / Center punch: 3x10x120mm	675
B- 69954	Botador cilíndrico / Pin punch: 4x10x130mm Botador cónico / Taper punch: 3x10x120mm	700

HACHAS / AXES / HACHES / ÄXTE / ASCIA / BIJLEN / MACHADOS

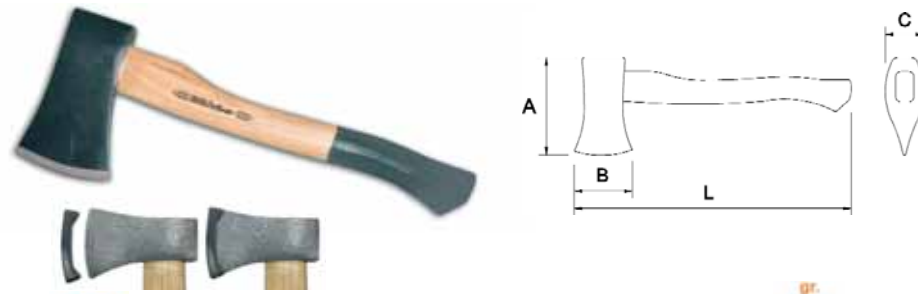

COD	L	A	B	C	gr.	
67231	450	144	95	21	700	6
67232		145		22	800	
67233	600	159	100	23	1000	
67234	700	174	110	27	1200	
67235		185	120	27	1500	
67236	800	195	130	28	2000	

MAZA CUÑA / WEDGE HAMMER / MASSE COIN / SPALTHAMMER / MARTELLO A CUNEO / SPLIJTHAMER / MALHOS

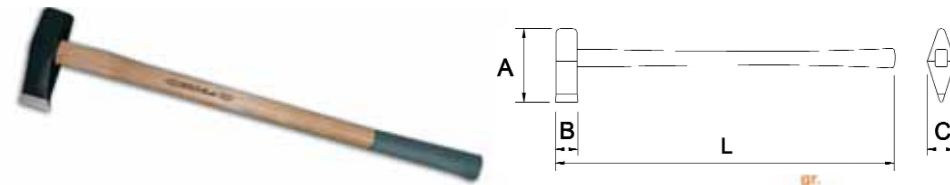

COD	L	A	B	C	gr.	
67237	900	204	65	55	300	6

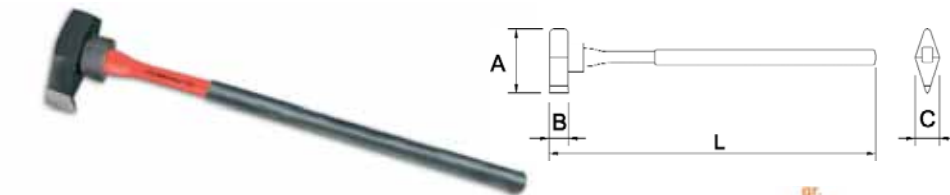

COD	L	A	B	C	gr.	
67238	900	204	65	55	300	6

FIBRA DE VIDRIO / FIBERGLASS / FIBRE DE VERRE / FIBRA DI VETRO / FIBERGLASSTIEL / FIBRA DE VIDRO

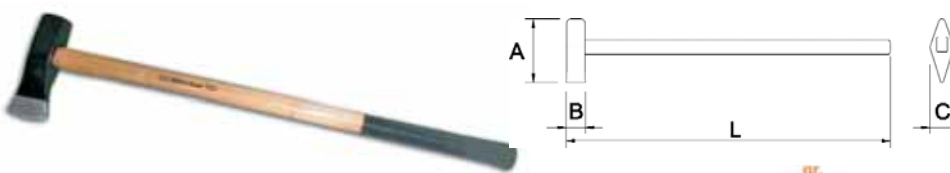

COD	L	A	B	C	gr.	
67239	900	208	90	52	250	6

HACHA BOMBERO / FIREMAN TYPE AXE / HACHE POUR POMPIERS / FEUERWEHRAXT / ASCIA TIPO PER POMPIERI
BRANDWEER BIJL / MACHADO DE BOMBEIRO

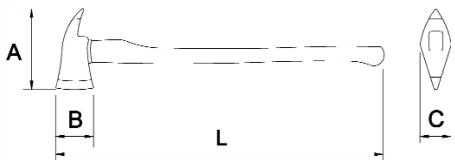
COD	L	A	B	C	Gr.	
67240	910	248	105	32	150	6





COD	L	A	B	C	Gr.	
67241	910	248	105	32	150	6

FIBRA DE VIDRIO / FIBERGLASS / FIBRE DE VERRE / FIBRA DI VETRO / FIBERGLASSTIEL / FIBRA DE VIDRO

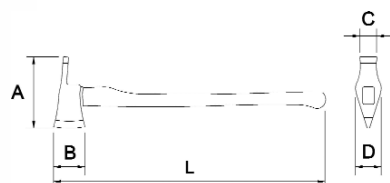
HACHA AZADA / HOE AXE / HACHE HOUE / WIEDEHOPFHACKE / ACE PER ZAPPA / MACHADO ENXADA

COD	L	A	B	C	D	Gr.	
67242	910	307	110	82	29	1500	6

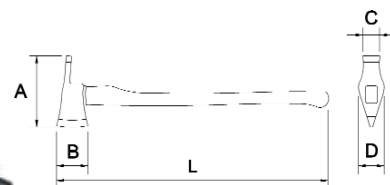
COD	L	A	B	C	D	Gr.	
67243	910	307	110	82	29	1500	6

FIBRA DE VIDRIO / FIBERGLASS / FIBRE DE VERRE / FIBRA DI VETRO / FIBERGLASSTIEL / FIBRA DE VIDRO

MACHETES / MACHETS / MACHETTES / MESSER / MACETE / CATANAS

COD	L	gr.	
67245	19"	540	48
67246	21"	630	



COD	L	gr.	
67247	16"	570	48
67248	18"	600	
67249	19"	615	



COD	L	gr.	
67250	16"	400	48
67251	18"	450	
67252	21"	530	



COD	L	gr.	
67253	16"	420	48
67254	18"	460	
67255	21"	550	



COD	L	gr.	
67256	18"	430	48
67257	20"	450	
67258	22"	490	



SIERRAS DE CORONA BIMETAL / BI-METAL HOLE SAWS / SCIES CLOCHES BI-MÉTAL / BI-MATEALL LOCHSÄGEN / SEGHE A TAZZA BI-METAL / BI-METAL GATZAGEN / SERRAS CRANEANAS BI-METÁLICAS

HSS BI-METAL

4/6 TPI

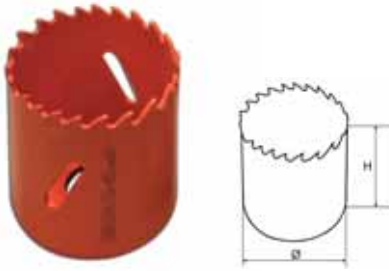



COD	Ø (mm)	Ø (inch.)	H (mm)	r.p.m.	r.p.m.					
					acero dulce mild steel	inox	fundición casting	aluminio aluminium	latón brass	madera wood
64550	14	9/16"	54	64601	620	300	400	900	790	3000
64551	16	5/8"			545	260	360	810	735	
64552	17	11/16"			510	250	340	770	690	
64553	19	3/4"			460	220	300	685	620	
64664	20	-			430	210	290	650	590	
64554	21	13/16"			415	200	275	620	560	
64555	22	7/8"			395	190	260	590	535	
64556	24	15/16"			360	175	240	540	490	
64557	25	1"			350		235	525	470	
64558	27	1.1/16"			50	64601	320	160	215	
64559	28	-	310	150			205	450	405	
64560	29	1.1/8"	300	145			200	430	390	
64561	30	1.13/16"	290	140			190	410	370	
64562	32	1.1/4"	270	130			180	390	355	
64563	33	1.5/16"	265	125			175	370	335	
64564	35	1.3/8"	250	120			165	350	320	
64565	37	1.7/16"	235	115			155	340	310	
64566	38	1.1/2"	230	110			150	325	295	
64567	40	1.9/16"	215	105			145	315	285	
64568	41	1.5/8"	210	100	140	300	275			
64569	43	1.11/16"	200	95	135	295	270	2100		
64570	44	13/4"	195		130	280	255			
64571	46	1.13/16"	190	90	125	270	245	2000		
64572	48	1.7/8"	180		120	255	230			
64573	51	2"	170	85	115	245	220			
64574	52	1.1/16"	165	80	110	240	215			
64575	54	2.1/8"	160	75	105	230	205	1800		
64576	57	2.1/4"	150		100	220	200			
64577	59	2.51/16"	145	70	100	215	195	1500		
64578	60	2.3/8"	140		95	205	185			
64579	64	2.1/2"	135	65	90	200	180	1200		
64580	65	2.9/16"			195	175	175			
64581	67	2.5/8"	130	60	85	190	170	1000		
64582	70	2.3/4"	125		85	185	165			
64583	73	2.7/8"	120	55	80	180	160	800		
64584	76	3"	115		80	170	150			
64585	79	3.1/8"	110	50	75	165	145	700		
64586	83	3.1/4"	105		75	155	140			
64587	86	3.3/8"	100	45	70	150	135	600		
64588	89	3.1/2"	95		65	145	130			
64589	92	3.5/8"	90	40	65	140	125	500		
64590	95	3.3/4"			60	135	120			
64591	98	3.7/8"	88	35	60	130	120	400		
64592	102	4"	85		125	110				
64593	105	4.1/8"	83	50	55	120	110	300		
64594	108	4.1/4"	80		50	115	105			
64595	110	4.5/16"	78	45	50	110	100	200		
64596	114	4.1/2"	76		45	100	90			
64597	121	4.3/4"	72	30	45	100	90	150		
64598	127	5"	68		40	90	85			
64599	140	5.1/2"	62	25	30	85	75	100		
64600	152	6"	55	25	30	85	75	100		

19

CORTE / CUTTING / OUTILS COUPANTS / SCHNEIDWERKZEUG / ARCHETTI SNIJWERKTUIGEN

HUSILLO / ARBOR / VERRIN / HALTER / SUPPORTO / HOUDER / FUSO

COD	Ø (mm)		
64601	14-30	3/8" - 9,52	1
64602	32-152	7/16" - 11,1	



CONECTOR ADAPTADOR ROSCA / THREAD CONNECTION ADPTER / CONNECTEUR ADAPTATEUR DE FILETAGE / ADAPTOR VERBINDUNGSADAPTER FUR GEWINDE / ADDATTATORE CONNETTORE PER FILIERA / ADAPTADOR DE ROSCA

COD			
64612	20	10	1



ALARGADERA / EXTENSION / RALLONGE / VERLÄNGERUNG / PROLUNGA / VERLENGSTUK / EXTENÇÃO

COD		L			
64613	7/16" - 11,1	300	290	10	1



BROCA / DRILL / FORET CONIQUE / BOHRER / PUNTE / BOOR / BROCA

COD				
64614	75	15	10	1







SETS

COD	Ø (mm)				
64615	19-22-35 38-44-67	64601-64602	64612	1500	1



COD	Ø (mm)				
64651	16-21-25 32-40-51	64601-64602	64612	1500	1



COD	Ø (mm)					
64616	19-22-29-35-38 44-51-57-64-67	64601-64602	64612	64613	300	1



BROCA ESCALONADA / STEP DRILL / FORET ÉTAGÉ / SPIRALBOHRER / PUNTA SCANALATA SPIRAALBOOR / BROCA ESCALONADA

COD	Ø (mm)			
64617	4-12	25	1	1
64618	4-20	60		
64619	4-30	180		

SET

COD	Ø (mm)		
64620	4-12	1	1
	4-20		
	4-30		



EXTRACTORES DE TORNILLOS / SCREW STRACTORS / EXTRACTEUR DE VIS SCHRAUBENAUSDREHER / ESTRATTORI / TAPEINDUITHALERS / EXTRACTORES DE PERNOS

COD	M	← L →	← A →	← B →	← D →	
61583	3-6	52,5	2,6	3,9	2,5	5
61584	6-8	57	3,0	4,3	3,0	10
61585	8-11	65	4,0	6,3	4,5	20
61586	11-14	75	4,5	7,5	6,0	30
61587	14-18	83	7,0	10,8	8,0	50
61588	18-25	92,5	8,9	14,9	11,0	100
61589	25-35	97	9,7	18,9	14,0	150
61590	>35	101,5	14,9	24,0	20,0	200

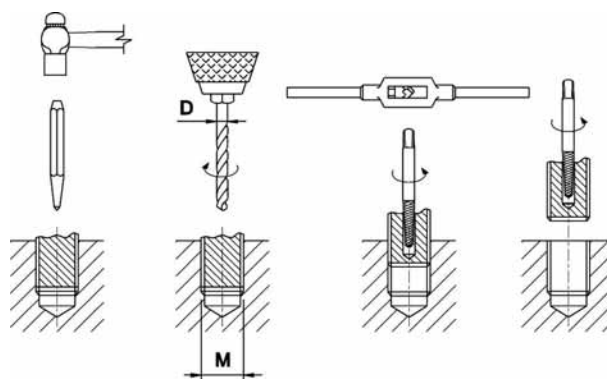



SET	Composición/Composition	pcs.	
61591	61583, 61584, 61585 61586, 61587	5	100
61592	61583, 61584, 61585 61586, 61587, 61588	6	200
61593	61583, 61584, 61585 61586, 61587, 61588 61589, 61590	8	750





NEW

SACABOCADOS / HOLLOW PUNCHES / EMPORTE PIÈCES / HENKELLOCHEISEN / SACA-
BOCADOS / HOLPIJPEN / SACA BOCADOS

COD	PCS	O.D (mm)		
64670	10	5-6-8-10-12 5-16-20-25-32	90°	1



COD	Ø (mm)			
64671	5	27	15	10
64672	6		20	
64673	8		25	
64674	10		30	
64675	12,5		40	
64676	16		50	
64677	20		60	
64678	25		80	
64679	32			



COD	Ø (mm)		
64680	5-32	250	1



CIZALLA CORTACHAPAS / METAL PLATE CUTTER / CISAILLE COUPE TOLE / SCHNEIDER FÜR METALLPLATTE / CESAIA TAGLIA LAMIERA / STAALPLAATSNIJDER / GUILHOTINA CORTA CHAPAS



CE *G12
NEW



COD	V	W	Kg
60269	230V	660W	3,5

Especificaciones técnicas / Technical specification / Détails techniques

Para chapas de acero, acero inoxidable, aluminio, cobre... / for steel, stainless steel, aluminium, copper... Pour de la tôle d'acier, d'Inox, d'Aluminium, de cuivre...	●
Espesores máximos de chapa / Plate maximum thickness / Epaisseurs maximum de tôle	
800N/mm2	1,5
600N/mm2	2,5
400N/mm2	3,2
200N/mm2	4
Mínimo radio de corte curvo / Minimum radio of curved cutting / Rayon minimum de courbure en coupure	500mm
Velocidad cuchillas / Blade Speed / Vitesse de lame	1600spm
Dimensiones generales / Overall dimensions / Dimensions générales	200x90x250mm
Longitud de cable / Wire lenght / Longueur de câble	2,5m
Juego de cuchillas / Blade set / Jeu de lames	85200
LLave allen / Allen Key / Clé mâle	4mm
Galga de calibración / Calibration Gage / Jauge	●
Empuñadura de puente / Bridge type hilt / Manche en U	●
Cuchillas reversibles / Reversible blades / Lames réversibles	●
Cuchillas reafilables / Resharpenable blades / Lames affutables	●
Cuchillas ajustables / Adjustable blades / Lames ajustables	●
Buena visión de línea de corte / Good view of cutting line / Bonne vision de ligne de coupe	●
Fácil manejo para zurdos / Easy use for left-handed people / Utilisation facile par les sourds	●



CORTACHAPAS / PLATE CUTTER / COUPE TOLE / METALLPLATTE SCHNEIDER
TAGLIALAMIERA / METAALPLAATSNIJDER / CORTA CHAPAS

COD	V	W	Kg.
60126	230V	560W	3
60127	110V		
Especificaciones técnicas / Technical specification / Détails techniques			
Taladro incluido / Included drill machine / Perceuse inclus			●
Estuche de aluminio / Aluminium case / Etui en aluminium			●
Cabezas de corte a izquierdas / Left cutting heads / Têtes de coupe à gauche			2 pcs
Cabezas de corte a derechas / Right cutting heads / Têtes de coupe à droite			
Max. espesor chapa acero / Steel max. thickness / Epaisseur maximum tôle en acier			1,5mm
Max. espesor chapa acero INOX / Stainless steel max. thickness / Epaisseur maximum tole en INOX			1mm

